



Copper Development
Association Inc.
Copper Alliance

Copper Tube Handbook

Industry Standard Guide for the Design and Installation of Copper Piping Systems





CONTENTS

INTRODUCTION	7
UNDERSTANDING COPPER TUBE	
1. STANDARD TUBES	9
Types of Copper Tube.....	9
Tube Properties.....	9
Identification of Copper Tube.....	9
Introduction To Copper Tube, Piping and Fittings.....	10
2. SELECTING THE RIGHT TUBE FOR THE JOB	11
Advantages of Copper Tube.....	11
Minimum Recommendations for Various Applications.....	11
3. DESIGN AND INSTALLATION DATA	13
Pressure System Sizing.....	13
Pressure Ratings and Burst Strength.....	15
Drainage Plumbing Systems.....	17
Copper Tube for Heating Systems.....	19
Ground Source Heat Pumps.....	20
Nonflammable Medical Gas Piping Systems.....	20
Medical Gas Copper Installation.....	21
Snow Melting Systems.....	22
Irrigation and Agricultural Sprinkler Systems.....	22
Solar Energy Systems.....	22
Copper-Iron Alloy Tube and Fittings for High Pressure HVAC/R Applications.....	23
General Considerations.....	25
WORKING WITH COPPER TUBE	
4. BENDING	30
Bending Copper Tube.....	30
TABLE 4.1. Bending Guide for Copper Tube	30
5. JOINING METHODS	32
Solder or Brazed Joints.....	32
No-flame Joints.....	32
Additional Joining Methods.....	32
6. FITTINGS, SOLDERS, FLUXES	33
Fittings.....	33
Solders.....	33
Fluxes.....	34



7. SOLDERED JOINTS	35
Measuring and Cutting	35
Reaming	36
Cleaning	36
Applying Flux	37
Assembly and Support	38
Heating	38
Applying Solder	39
Cooling and Cleaning	40
Testing	40
Soldering Preparation	41
Soldering and Brazing Copper Alloy Flanges	41
Fluxing & Soldering Techniques	41
Soldering of No-Lead Copper Alloy Fittings, Valves & Components	41
8. BRAZED JOINTS	42
Brazing Filler Metals	42
Fluxes	42
Assembly	43
Applying Heat and Brazing	43
Horizontal and Vertical Joints	43
Removing Residue	44
General Hints and Suggestions	44
Brazing Copper Tube	44
Testing	44
Purging	44
How to Braze Threaded Copper Adapters	44
9. FLARED JOINTS	45
How-To: Use Flare Joints for Copper	46
10. ROLL GROOVE JOINTS	47
Preliminary Requirements	47
Installation Steps	47
Testing	49
11. PRESS-CONNECT JOINTS	50
Preliminary Requirements	50
Installation Steps	51
Press-Connect Joints for HVACR Applications	53
Testing	54
12. PUSH-CONNECT JOINTS	55
Preliminary Requirements	55
Installation Steps	56
Testing	58

13. MECHANICALLY FORMED EXTRUDED OUTLETS	59
Preliminary Requirements	59
Installation Steps	60
Testing	63
Solderless Fittings	63

TECHNICAL DATA

14. TABLES AND FIGURES	65
TABLE 14.1. Copper Tube: Types, Standards, Applications, Tempers, Lengths	65
TABLE 14.2A. Dimensions and Physical Characteristics of Copper Tube: Type K	66
TABLE 14.2B. Dimensions and Physical Characteristics of Copper Tube: Type L	67
TABLE 14.2C. Dimensions and Physical Characteristics of Copper Tube: Type M	68
TABLE 14.2D. Dimensions and Physical Characteristics of Copper Tube: DWV	69
TABLE 14.2E. Dimensions and Physical Characteristics of Copper Tube: ACR	70
TABLE 14.2F. Dimensions and Physical Characteristics of Copper Tube: Medical Gas, K and L	71
TABLE 14.3A. Calculated Rated Internal Working Pressures for Copper Tube: Type K	72
TABLE 14.3B. Calculated Rated Internal Working Pressure for Copper Tube: Type L	73
TABLE 14.3C. Calculated Rated Internal Working Pressure for Copper Tube: Type M	74
TABLE 14.3D. Calculated Rated Internal Working Pressure for Copper Tube: DWV	75
TABLE 14.3E. Calculated Rated Internal Working Pressure for Copper Tube: ACR	76
TABLE 14.4A. Pressure-Temperature Ratings of Soldered and Brazed Joints	77
TABLE 14.4B. Pressure-Temperature Ratings of No-flame Joints	78
TABLE 14.5. Actual Burst Pressures Types K, L and M Copper Water Tube	79
TABLE 14.6. Pressure Loss of Water Due to Friction in Types K, L and M Copper Tube	80
TABLE 14.6. Pressure Loss of Water Due to Friction in Types K, L and M Copper Tube	81
TABLE 14.7. Pressure Loss in Fittings and Valves Expressed as Equivalent Length of Tube	82
TABLE 14.7A. Pressure Loss in HVACR Elbows Expressed as Equivalent Length of Tube	83
TABLE 14.8. Radii of Coiled Expansion Loops and Developed Lengths of Expansion Offsets	84
TABLE 14.9. Dimensions of Solder Joint Ends for Wrought Pressure Fittings	85
TABLE 14.10. Solder Requirements for Solder Joint Pressure Fittings	86
TABLE 14.11. Typical Brazing Filler Metal Consumption	87
TABLE 14.12. Filler Metals for Brazing	88
FIGURE 14.1. Collapse Pressure of Copper Tube, Types K, L and M	89
FIGURE 14.2. Expansion vs. Temperature Change for Copper Tube	90
FIGURE 14.3. Coiled Expansion Loops and Expansion Offsets	91
FIGURE 14.4. Selected Pressure Fittings	92
FIGURE 14.5. Dimensions of Solder Joint Fitting Ends	93
FIGURE 14.6. Melting Temperature Ranges for Copper and Copper Alloys, Brazing Filler Metals, Brazing Flux and Solders	94
FIGURE 14.7. Brazing Flux Recommendations	95





INTRODUCTION

Since primitive man first discovered copper, the red metal has constantly served the advancement of civilization. Archeologists probing ancient ruins have discovered that this enduring metal was a great boon to many peoples. Tools for handicraft and agriculture, weapons for hunting, and articles for decorative and household uses were wrought from copper by early civilizations. The craftsmen who built the great pyramid for the Egyptian Pharaoh Cheops fashioned copper pipe to convey water to the royal bath. A remnant of this pipe was unearthed some years ago still in usable condition, a testimonial to copper's durability and resistance to corrosion.

Modern technology, recognizing that no material is superior to copper for conveying water, has reconfirmed it as the prime material for such purposes. Years of trouble-free service in installations here and abroad have built a new reputation for copper piping in its modern form—light, strong, corrosion resistant tube. It serves all kinds of buildings: single-family homes, high-rise apartments and industrial, commercial and office buildings.

Today, copper tube for the plumbing, heating and air-conditioning industries is available in drawn and annealed tempers (referred to in the trades as "hard" and "soft") and in a wide range of diameters and wall thicknesses. Readily available fittings serve every design application. Joints are simple, reliable and economical to make—additional reasons for selecting copper tube.

Today, nearly 5,000 years after Cheops, copper developments continue as the industry pioneers broader uses for copper tube in engineered plumbing systems for new and retrofitted residential, industrial and commercial installations.

A note on QR Codes in the handbook: throughout the handbook there are videos that can be viewed by scanning the QR code in the video thumbnail - such as the image to the right. QR codes are machine-scannable images that can be viewed by mobile devices such as a smartphone or tablet camera app. Center the QR code in the device's camera app and the video should open.



NOTICE: This Handbook has been prepared for the use of journeymen plumbers, pipefitters, refrigeration fitters, sprinkler fitters, plumbing and heating contractors, engineers, and others involved in the design or installation of plumbing, heating, air-conditioning, refrigeration and other related systems. It has been compiled from information sources Copper Development Association Inc. (CDA) believes to be competent. However, recognizing that each system must be designed and installed to meet the particular circumstances, CDA assumes no responsibility or liability of any kind in connection with this Handbook or its use by any person or organization and makes no representations or warranties of any kind hereby.

Copyright © 2024 Copper Development Association Inc., 1660 International Dr. Suite 600, McLean, VA 22102





UNDERSTANDING COPPER TUBE

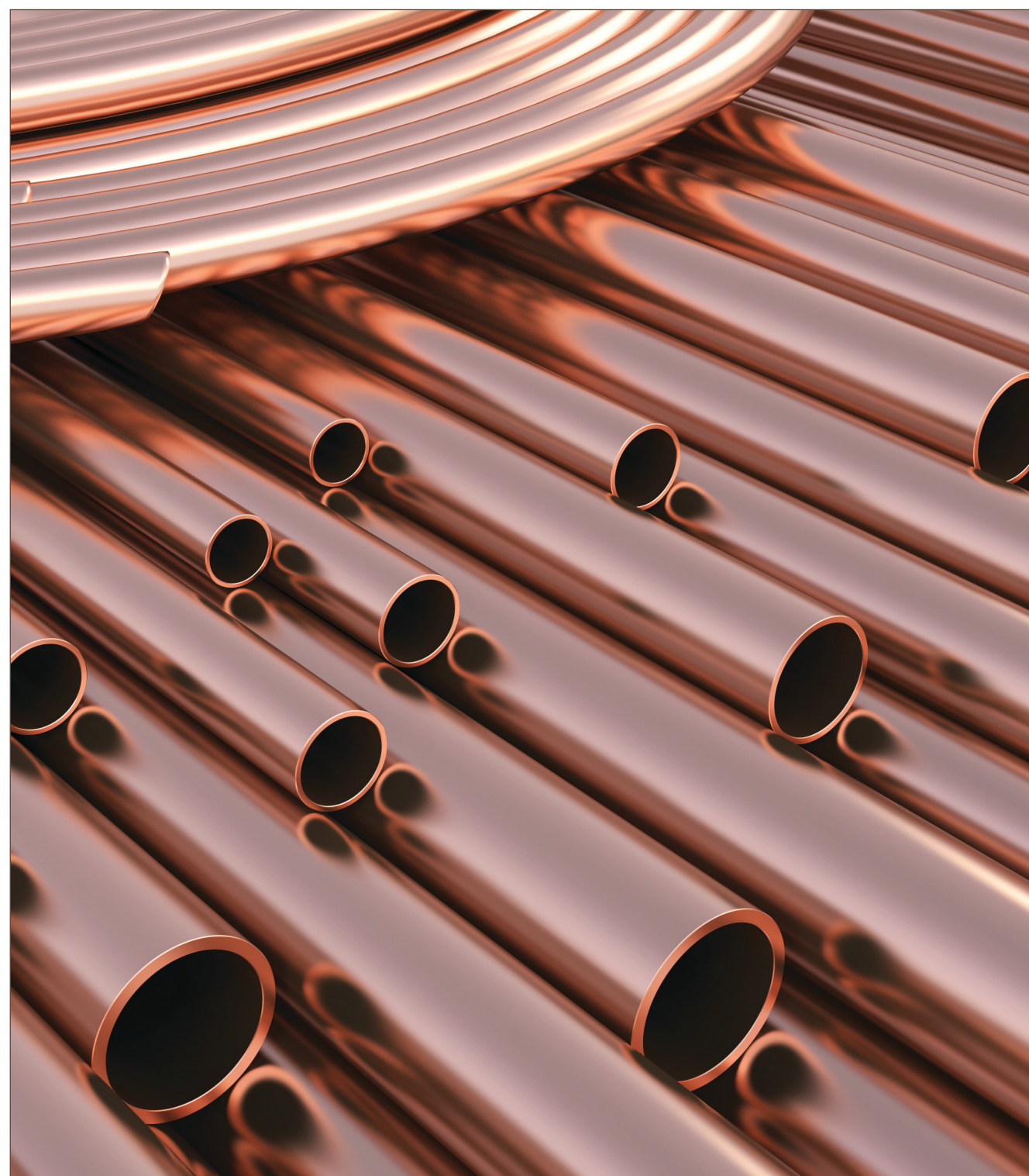

1. STANDARD TUBES

Types of Copper Tube

Long lasting copper tube is a favorite choice for plumbing, heating, cooling and other systems. In the United States, it is manufactured to meet the requirements of specifications established by ASTM International.

All tube supplied to these ASTM standards is a minimum of 99.9 percent pure copper. The copper customarily used for tube supplied to these specifications is deoxidized with phosphorus and referred to as UNS C12200 or DHP¹ Copper. Other coppers may also be used.

Table 14.1 identifies the six standard types of copper tube and their most common applications.² The table also shows the ASTM Standard appropriate to the use of each type along with a listing of its commercially available lengths, sizes and tempers.

Types K, L, M, DWV and Medical Gas tube are designated by ASTM standard sizes, with the actual outside diameter always 1/8-inch larger than the standard size designation. Each type represents a series of sizes with different wall thicknesses. Type K tube has thicker walls than Type L tube, and Type L walls are thicker than Type M, for any given diameter. All inside diameters depend on tube size and wall thickness.

Copper tube for air-conditioning and refrigeration field service (ACR) is designated by actual outside diameter.

"Temper" describes the strength and hardness of the tube. In the piping trades, drawn temper tube is often referred to as "hard" tube and annealed as "soft" tube. Tube in the hard temper condition is usually joined by soldering or brazing, using capillary fittings or by welding.

Tube in the soft temper can be joined by the same techniques and is also commonly joined by the use of flare-type and compression fittings. It is also possible to expand the end of one tube so that it can be joined to another by soldering or brazing without a capillary fitting—a procedure that can be efficient

and economical in many installations.

Tube in both the hard and soft tempers can also be joined by a variety of "mechanical" joints that can be assembled without the use of the heat source required for soldering and brazing.

Tube Properties

The dimensions and other physical characteristics of Types K, L, M and DWV tube are given in **Tables 14.2a-d**. All four types are used for both pressure and non-pressure applications within the range of their respective safe working pressures as described in **Tables 14.3a-d**.

The dimensions and physical characteristics of ACR tube and Medical Gas tube are given in **Tables 14.2e** and **14.2f**.

Identification of Copper Tube

Copper tube, Types K, L, M, ACR, DWV and Medical Gas, must be permanently marked (incised) in accordance with its governing specifications to show tube type, the name or trademark of the manufacturer, and the country of origin. In addition to incised markings, hard tube will have this information printed on it in a color which distinguishes its tube type (**See Table 14.1**).

Footnotes:

- 1. Phosphorous-Deoxidized, High Residual Phosphorous Copper
- 2. There are many other copper and copper alloy tubes and pipes available for specialized applications. For more information on these products, **contact CDA**.



Introduction To Copper Tube, Piping and Fittings



Introduction To Copper Tube, Piping and Fittings

To view the online video, please click the image above, scan the QR code, or follow the link: <https://www.youtube.com/watch?v=ZK5OGg5w8oM>.



2. SELECTING THE RIGHT TUBE FOR THE JOB

Advantages of Copper Tube

Strong, long lasting, copper tube is the leading choice of modern contractors for plumbing, heating and cooling installations in all kinds of residential and commercial buildings. The primary reasons for this are:

- **Copper is economical.** The combination of easy handling, forming and joining permits savings in installation time, material and overall costs. Long-term performance and reliability mean fewer callbacks, and that makes copper the ideal, cost-effective tubing material.
- **Copper is lightweight.** Copper tube does not require the heavy thickness of ferrous or threaded pipe of the same internal diameter. This means copper costs less to transport, handles more easily and, when installed, takes less space.
- **Copper is formable.** Because copper tube can be bent and formed, it is frequently possible to eliminate elbows and joints. Smooth bends permit the tube to follow contours and corners of almost any angle. With soft temper tube, particularly when used for renovation or modernization projects, much less wall and ceiling space is needed.
- **Copper is easy to join.** Copper tube can be joined with capillary fittings. These fittings save material and make smooth, neat, strong and leak-proof joints. No extra thickness or weight is necessary to compensate for material removed by threading.
- **Copper is safe.** Copper tube will not burn or support combustion or decompose to toxic gases. Therefore, it will not carry fire through floors, walls and ceilings. Volatile organic compounds are not required for installation.
- **Copper is dependable.** Copper tube is manufactured to well-defined composition standards and marked with permanent identification so you know exactly what it is and

who made it. It is accepted by virtually every plumbing code.

- **Copper is long-lasting.** It has excellent resistance to corrosion and scaling, high mechanical strength, high-temperature resistance and lifetime resistance to UV degradation. Copper assures long, trouble-free service, which translates to satisfied customers and systems that last.
- **Copper is 100% recyclable.** Copper stands alone as an engineering material that can be recycled over and over without degradation in content or properties. This combined with copper's proven durability means that no copper used in a building today needs to enter a landfill.

Minimum Recommendations for Various Applications

It is up to the designer to select the type of copper tube for use in a particular application. Strength, formability and other mechanical factors often determine the choice. Plumbing and mechanical codes govern what types may be used. When a choice can be made, it is helpful to know which type of copper tube has and can serve successfully and economically in the following applications:

- **Underground Water Services** Use Type M hard for straight lengths joined with fittings, and Type L soft where coils are more convenient.
- **Water Distribution Systems** Use Type M for above and below ground.
- **Chilled Water Mains** Use Type M for all sizes.
- **Drainage and Vent Systems** Use Type DWV for above- and below-ground waste, soil and vent lines, roof and building drains and sewers.
- **Heating** For radiant panel and hydronic heating and for snow melting systems, use Type L



soft temper where coils are formed in place or prefabricated, Type M where straight lengths are used. For water heating and low-pressure steam, use Type M for all sizes. For condensate return lines, Type L is successfully used.

- **Solar Heating** See Heating section above. See also **Solar Energy Systems**. For information on solar installation and on solar collectors, contact CDA.
- **Fuel Oil, L.P. and Natural Gas Services** Use Type L or Type ACR tube with flared joints in accessible locations and brazed joints made using AWS A5.8 BAg series brazing filler metals in concealed locations.
- **Nonflammable Medical Gas Systems** Use Medical Gas tube Types K or L, suitably cleaned for oxygen service per NFPA Standard No. 99, *Health Care Facilities*.
- **Air-Conditioning and Refrigeration Systems** Copper is the preferred material for use with most refrigerants, including newer, natural refrigerants like CO₂, propane, isobutane and others (*copper is not recommended for use with ammonia*). Use Types L, ACR or as specified. In designing and installing HVACR systems the use of long-radius 90-degree elbows is recommended. Long-radius elbows reduce pressure drop by 15 - 20 percent over standard and short-radius elbows (see **Table 14.7a**).
- **Ground Source Heat Pump Systems** Use Types L or ACR where the ground coils are formed in place or prefabricated, or as specified.
- **Fire Sprinkler Systems** Use Type M hard. Where bending is required, Types K or L are recommended. Types K, L and M are all accepted by NFPA.
- **Low Temperature Applications** Use copper tube of Type determined by rated internal working pressures at room temperature as shown in **Tables 14.3a-e**. Copper tube retains excellent ductility at low temperatures to -452° F and yield strength and tensile strength increase as temperature is reduced to this point. This, plus its excellent thermal conductivity, makes an unusual combination of properties for heat exchangers, piping, and other components in cryogenic plants and other low temperature applications.
- **Compressed Air** Use copper tube of Types K, L or M determined by the rated internal working pressures as shown in **Tables 14.3a-c, e**. Brazed joints are recommended.

3. DESIGN AND INSTALLATION DATA

Pressure System Sizing

Designing a copper tube water supply system is a matter of determining the minimum tube size for each part of the total system by balancing the interrelationships of six primary design considerations:

1. Available main pressure;
2. Pressure required at individual fixtures;
3. Static pressure losses due to height;
4. Water demand (gallons per minute) in the total system and in each of its parts;
5. Pressure losses due to the friction of water flow in the system;
6. Velocity limitations based on noise and erosion.

Design and sizing must always conform to applicable codes. In the final analysis, design must also reflect judgment and results of engineering calculations. Many codes, especially the model codes, include design data and guidelines for sizing water distribution systems and also include examples showing how the data and guidelines are applied.

Small Systems

Distribution systems for single-family houses can usually be sized easily on the basis of experience and applicable code requirements, as can other similar small installations. Detailed study of the six design considerations above is not necessary in such cases.

In general, the mains that serve fixture branches can be sized as follows:

- Up to three 3/8-inch branches can be served by a 1/2-inch main.
- Up to three 1/2-inch branches can be served by a 3/4-inch main.

- Up to three 3/4-inch branches can be served by a 1-inch main.

The sizing of more complex distribution systems requires detailed analysis of each of the sizing design considerations listed above.

Pressure Considerations

At each fixture in the distribution system, a minimum pressure of 8 psi should be available for it to function properly - except that some fixtures require a higher minimum pressure for proper function, for example:

- Flush valve for blow-out and syphon-jet closets - **25 psi**
- Flush valves for water closets and urinals - **15 psi**
- Sill cocks, hose bibbs and wall hydrants - **10 psi**

Local codes and practices may be somewhat different from the above and should always be consulted for minimum pressure requirements.

The maximum water pressure available to supply each fixture depends on the water service pressure at the point where the building distribution system (or a segment or zone of it) begins. This pressure depends either on local main pressure, limits set by local codes, pressure desired by the system designer, or on a combination of these. In any case, it should not be higher than about 80 psi (pounds per square inch).

However, the entire water service pressure is not available at each fixture due to pressure losses inherent to the system. The pressure losses include losses in flow through the water meter, static losses in lifting water to higher elevations in the system, and friction losses encountered in flow through piping, fittings, valves and equipment.

Some of the service pressure is lost immediately in flow through the water meter, if there is one. The amount of loss depends on the relationship between



flow rate and tube size. Design curves and a table showing these relationships appear in most model codes and are available from meter manufacturers.

Some of the main pressure will also be lost in lifting the water to the highest fixture in the system. The height difference is measured, starting at the meter, or at whatever other point represents the start of the system (or the segment or zone) being considered. To account for this, multiply the elevation of the highest fixture, in feet, by the factor 0.434, the pressure exerted by a 1-foot column of water. This will give the pressure in psi needed to raise the water to that level. For example, a difference in height of 30 feet reduces the available pressure by 13 psi ($30 \times 0.434 = 13.02$).

Friction losses in the system, like losses through the water meter, are mainly dependent on the flow rate of the water through the system and the size of the piping. To determine these losses, water demand (and thus, flow rate) of the system must first be determined.

Water Demand

Each fixture in the system represents a certain demand for water. Some examples of approximate water demand in gallons per minute (gpm) of flow, are:

- Drinking fountain - 0.75
- Lavatory faucet - 2.0
- Lavatory faucet, self closing - 2.5
- Sink faucet, WC tank ball cock - 3.0
- Bathtub faucet, shower head, laundry tub faucet - 4.0
- Sill cock, hose bibb, wall hydrant - 5.0
- Flush valve (depending on design) - 3.5
- Shower head - 2.2

Adding up numbers like these to cover all the fixtures in an entire building distribution system would give the total demand for water usage in gpm, if all of the fixtures were operating and flowing at the same time—which of course does not happen. A reasonable estimate of demand is one based on the extent to

which various fixtures in the building might actually be used simultaneously. Researchers at the National Institute of Standards and Technology studied this question some years ago. They applied probability theory and field observations to the real-life problem of simultaneous usage of plumbing fixtures.

The result was a system for estimating total water demand is based on reasonable assumptions about the likelihood of simultaneous usage of fixtures. Out of this study came the concept of *fixture units*.

Each type of fixture is assigned a fixture unit value which reflects:

1. Its demand for water, that is, the flow rate into the fixture when it is used;
2. The average time duration of flow when the fixture is used;
3. The frequency with which the fixture is likely to be used.

Assigned fixture unit values vary by jurisdiction. Consult local plumbing codes for values used in your area.

Totaling the fixture unit values for all the fixtures in a system, or for any part of the distribution system, gives a measure of the load combined fixtures impose on the plumbing distribution and supply system. This fixture unit total may be translated into expected maximum water demand following the procedure prescribed by your local code.

Keep in mind the demand calculations just described apply to fixtures that are used *intermittently*. To this must be added the actual demand in gpm for any fixtures which are designed to run continuously when they are in use; for example, air-conditioning systems, lawn sprinkler systems and hose bibbs.

Pressure Losses Due to Friction

The pressure available to move the water through the distribution system (or a part of it) is the main pressure minus:

1. The pressure loss in the meter;
2. The pressure needed to lift water to the highest fixture (static pressure loss);
3. The pressure needed at the fixtures themselves.

The remaining available pressure must be adequate to overcome the pressure losses due to friction encountered by the flow of the total demand (intermittent plus continuous fixtures) through the distribution system and its various parts. The final operation is to select tube sizes in accordance with the pressure losses due to friction.

In actual practice, the design operation may involve repeating the steps in the design process to re-adjust pressure, velocity and size to achieve the best balance of main pressure, tube size, velocity and available pressure at the fixtures for the design flow required in the various parts of the system.

Table 14.6 shows the relationship among flow, pressure drop due to friction, velocity and tube size for Types K, L and M copper water tube. These are the data required to complete the sizing calculation.

NOTE: Values are not given for flow rates that exceed the maximum recommendation for copper tube.

For the tube sizes above about 1-1/4 inch, there is virtually no difference among the three types of tube in terms of pressure loss. This is because the differences in cross sectional area of these types become insignificant as tube size increases. In fact, for this reason, the value for Type M tube given in **Table 14.6** can be used for DWV tube as well.

Pressure loss values in **Table 14.6** are given per linear foot of tube. In measuring the length of a system or of any of its parts, the total length of tube must be measured, and for close estimates, an additional amount must be added on as an allowance for the extra friction losses that occur as a result of valves and fittings in the line. **Table 14.7** shows these allowances for various sizes and types of valves and fittings.

Water Velocity Limitations

To avoid excessive system noise and the possibility of erosion-corrosion, the designer should not exceed flow velocities of 8 feet per second for cold water and 5 feet per second in hot water up to approximately 140°F. In systems where water temperatures routinely exceed 140°F, lower flow velocities such as 2 to 3 feet per second should not be exceeded. In addition, where 1/2-inch and smaller tube sizes

are used, to guard against localized high velocity turbulence due to possibly faulty workmanship (e.g. burrs at tube ends which were not properly reamed/deburred) or unusually numerous, abrupt changes in flow direction, lower velocities should be considered. Locally aggressive water conditions can combine with these two considerations to cause erosion-corrosion if system velocities are too high.

Due to constant circulation and elevated water temperatures, particular attention should be paid to water velocities in circulating hot water systems. Both the supply and return piping should be sized so that the maximum velocity does not exceed the above recommendations. Care should be taken to ensure that the circulating pump is not oversized, and that the return piping is not undersized; both are common occurrences in installed piping systems.

Table 14.6 applies to copper tube only, and should not be used for other plumbing materials. Other materials require additional allowances for corrosion, scaling and caking *which are not necessary for copper*. This is because copper normally maintains its smooth bore throughout its service life.

Pressure Ratings and Burst Strength

There are various methods for determining the recommended, allowable or rated internal pressure-temperature ratings for piping materials and systems. These include calculated ratings based on basic material properties, such as tensile and yield stress, piping dimensions and engineering correlations. Oftentimes this is preferred since it reduces the amount of testing required. However, pressure ratings based on actual material performance may also be developed and used. These generally require more extensive testing across the product size range and anticipated stress/strain regimes than the calculated methods, but can provide more accurate and robust ratings.

Rated Pressures Based on Calculation

As for many piping materials, the calculated allowable internal pressure for copper tube in service is commonly based on the formula used in the American Society of Mechanical Engineers Code for Pressure Piping (ASME B31):

$$P = \frac{2S(t_{\min} - C)}{D_{\max} - 0.8(t_{\min} - C)}$$

WHERE:

P=allowable pressure, psi
S=maximum allowable stress in tension, psi
t_{min}=wall thickness (min.), in.
D_{max}=outside diameter (max.), in.
C=a constant

For copper tube, because of copper's superior corrosion resistance, the B31 code permits the

$$P = \frac{2St_{\min}}{D_{\max} - 0.8t_{\min}}$$

factor C to be zero. Thus the formula becomes:

The value of S in the formula is the maximum allowable stress (ASME B31) for continuous long-term service of the tube material. It is only a small fraction of copper's ultimate tensile strength or of the burst strength of copper tube and has been confirmed to be safe by years of service experience and testing. The allowable stress value depends on the service temperature and on the temper of the tube, drawn or annealed. The downside of utilizing this calculated pressure rating is that it underestimates the actual safe performance of the tube since it is overly conservative when applied to thin wall tubing (where the diameter to wall thickness ratio is greater than 10) like the commercially available copper tubes covered in this handbook. In addition, it does not account for the strain-hardening characteristics of copper tube that can increase the strength (true stress) over seven times.

In **Tables 14.3a, b, c, and d**, the calculated rated internal working pressures based on the ASME (Boardman) equation are shown for both annealed (soft) and drawn (hard) Types K, L, M and DWV copper tube for service temperatures from 100°F

to 400°F. The ratings for drawn tube can be used for soldered systems and systems using properly designed mechanical joints. Fittings manufacturers can provide information about the strength of their various types and sizes of fittings.

When welding or brazing is used to join tubes, the annealed ratings must be used, since the heating involved in these joining processes will anneal (soften) the hard tube. This is the reason that annealed ratings are shown in **Table 14.3c** for Type M and **Table 14.3d** for DWV tube, although they are not furnished in the annealed temper. **Table 14.3e** lists allowable internal working pressures for ACR tube.

In designing a system, tube, fitting and joint ratings must be considered collectively, because the lower of the ratings (tube, fitting or joint) will govern the maximum installation design pressure. Most tubing systems are joined by soldering or brazing. Rated internal working pressures for such joints are shown in **Table 14.4a**. These ratings are for all types of tube with standard solder joint pressure fittings and DWV fittings. In soldered tubing systems, the rated strength of the joint often governs design.

When brazing, use the ratings for annealed tube found in **Tables 14.3a-e** as brazing softens (anneals) the tube near the joints (the heat affected zone). Joint ratings at saturated steam temperatures are shown in **Table 14.4a**.

The pressures at which copper tube will actually burst are many times the rated working pressures. Compare the actual values in **Table 14.5** with the rated working pressures found in **Tables 14.3a, 14.3b and 14.3c**. The very conservative working pressure ratings give added assurance that pressurized systems will operate successfully for long periods of time. The much higher burst pressures measured in tests indicate that tubes are well able to withstand unpredictable pressure surges that may occur during the long service life of the system. Similar conservative principles were applied in arriving at the working pressures for brazed and soldered joints. The allowable stresses for the soldered joints assure joint integrity under full rated load for extended periods of time. Short-term strength and burst pressures for soldered joints are many times higher. In addition, safety margins were factored into calculating the joint strengths.

Rated Pressures Based on Performance Testing

Recognizing the limitations and overly conservative nature of establishing pressure ratings through calculation, it is possible to take advantage of the greater strength offered by thin-wall copper tube by establishing pressure ratings based on performance testing, such as burst and fatigue testing. This allows the system designer to specify copper tube with larger diameter to wall thickness ratios, thus reducing the amount of copper in the tube wall and optimizing both material use and cost.

Generally, performance testing is based on the operating regimes within which the piping system is expected to operate, with accelerated test methods and safe design factors applied to ensure that the tube is robust enough to withstand pressures well in excess of the test parameters.

An example of this performance rating is the testing required by the UL 207 *Standard for Safety for Refrigerant-Containing Components and Accessories, Nonelectrical*. Utilizing this standard, copper tube can be listed with a pressure rating higher than the calculated rated pressure shown in **Tables 14.3a - 14.3e** provided that the manufacturer can demonstrate for each tube size and wall thickness that the tube can withstand a pressure of three times the proposed rating, and withstand a pressure cyclic fatigue test for no less than 250,000 cycles without failure. Several manufacturers of copper tube and fittings have tested and received listings using this standard such that copper tube and fittings can be used in HVACR systems and equipment operating above the calculated rated pressures shown in **Tables 14.3a - 14.3e**.

Drainage Plumbing Systems

The design and installation of drainage systems range from simple to complex, depending on the type of building, the local code and the occupancy requirements. The local plumbing code will include requirements for acceptable materials, installation and inspection, and these must be followed as the first requirement of an acceptable job.

There are usually differences—sometimes minor, sometimes quite important—among plumbing codes. Among the features which differ from code

to code may be minimum tube sizes, permissible connected fixture loads, fittings and connections, methods of venting, supports and testing. Few codes are completely specific about installation details and leave the responsibility of proper and suitable installation to the designer and the contractor.

In large and multi-story buildings, the design will generally require the services of a mechanical engineer and a plumbing designer. The plumbing designer has the responsibility for coordinating the drainage system design within the overall building construction requirements. A good drainage design must accommodate the problems of installation space, building movement, support, expansion and contraction, pipe sleeves, offsets and provisions for necessary maintenance.

In residential buildings and small one- and two-story commercial buildings, the drainage piping is usually straightforward in design and simple in installation. Type DWV copper tube, installed with good workmanship by an experienced plumber, will provide many years of trouble-free service.

The smaller diameter of DWV tube and fittings makes it possible to install copper drainage systems where other competing piping materials would be impossible, difficult or more costly. For example, a 3-inch copper stack has only a 3-3/8-inch outside diameter at the fitting and can be installed in a 3-1/2 inch cavity wall.

Prefabrication

Considerable savings can be effected by prefabricating copper DWV subassemblies. Prefabrication permits work even when adverse weather prohibits activity on the job site. Simple, inexpensive jigs can be made to position the tube and fittings during assembly and help eliminate costly dimensional errors. Freedom of movement at the bench permits joints to be made more readily than at the point of installation, where working space may be limited.

Soldered joints are strong and rigid. Subassemblies can be handled without fear of damage. The lightweight features of copper DWV tube and fittings make it possible to handle fairly large assemblies. Other dependable drainage plumbing materials may weigh three to four times as much. Subassemblies

require a minimum of support when connected to a previously installed section of a drainage system.

Copper DWV tube has been used successfully for years in all parts of drainage plumbing systems for high-rise buildings—for soil and vent stacks and for soil, waste and vent branches. Copper tube's light weight and the ease with which it can be prefabricated have been especially important in high-rise drainage systems.

Expansion of DWV Systems

In high-rise buildings, expansion and contraction of the stack should be considered in the design. Possible movement of a copper tube stack as the temperature of the stack changes is about 0.001 inch per degree F per 10-foot floor. (See **Figure 14.2**) This is slightly more than for iron and steel pipe and considerably less than for plastic.

Since length, temperature changes and piping design itself are all involved in expansion, the designer must determine the best way to take care of expansion in any particular installation. One simple procedure for controlling thermal movement is to anchor the stack. Anchoring at every eighth floor will take care of an anticipated maximum temperature rise of 50°F; anchoring every four floors will take care of a 100°F maximum temperature rise. Care should be taken to avoid excessive stresses in the stack anchors or structure caused by thermal growth of the stack.

Perhaps the simplest effective anchor, when the stack passes through concrete floors, is to use pipe clamps and soldered fittings as shown in **Figure 3.1**. The pipe clamps can be placed above and below the floor, backed up by sliding the fittings tight against the clamps and soldering them in place. At all floors between anchors, sleeves in the concrete floors should be used to prevent lateral movement of the tube.

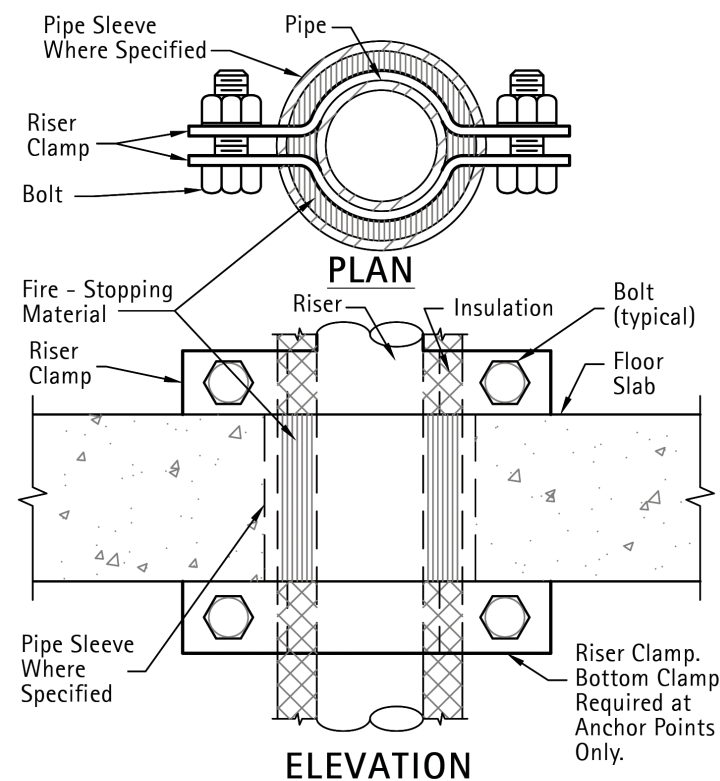

Figure 3.1. Arrangement for Anchoring Copper Tube Stack Passing Through Concrete Floor

Hydrostatic Testing of DWV Systems

While a copper drainage system is not ordinarily operated under pressure conditions, it must withstand the pressure of a hydrostatic test. The allowable pressures for copper DWV tube and soldered joints are given in **Table 14.3d** and in **Table 14.4a**, respectively.

To determine the vertical height that can be statically pressure tested (with water) in one segment, take the lowest applicable figure from **Table 14.3d** and **Table 14.4a** and multiply by 2.3. (A 2.3-foot column of water creates a pressure of 1 psi.) For example, if 50-50 tin-lead solder is used and the largest tube size is 4-inch at a service temperature of 100° F, multiply 80 (the lower of the solder joint rating of 80 in **Table 14.4a** and the tube rating of 257 in **Table 14.3d**) by 2.3; the result is 184. Thus, a 184-foot vertical segment of stack could be tested at once.

If 95-5 tin-antimony solder is the joining material, the lower of the corresponding rating for 4-inch tube from the tables, 257 (the tube governs) is multiplied by 2.3, equaling 591. Thus, theoretically, 591 feet (59 ten-foot stories) could be tested at once. If the joint is brazed, the value from **Table 14.3d** for annealed tube (150) governs. This value multiplied by 2.3 equals 345 feet, or only 34 stories at once. The actual vertical segment height tested is usually much less and depends on practical considerations on the job.

Copper Tube for Heating Systems

Copper tube is popular for heating systems in both new and remodeled buildings. Contractors have learned through experience that, all factors considered, copper tube remains superior to any substitute material. The advantages of light weight, choice of tempers, long-term reliability, and ease of joining, bending and handling are of major importance.

For example, where rigidity and appearance are factors, drawn tube is recommended. Annealed tube is particularly suitable for panel heating, snow melting, and short runs to radiators, convectors and the like. With annealed tube the need for fittings is reduced to a minimum, saving substantial installation labor and material.

Forced circulation hot water heating systems provide uniform heating and quick response to changes in heating load, require little maintenance and can be easily zoned to provide different temperature levels throughout the buildings. These systems use the smallest and most economical tube sizes with soldered joints and require little space for the installation. Also, in combination with the heating system and where permitted by code, domestic hot water can be heated directly—eliminating the need for a separate water heater.

Design and installation data for heating systems are given in *The Heating and Air-Conditioning Guide*, published by the American Society for Heating, Refrigeration and Air-Conditioning Engineers (ASHRAE), as well as in literature published by manufacturers of boilers and other heating devices. Those publications should be consulted for detailed design.

Steam-Heating Return Lines

For steam-heating systems, especially return lines, the outstanding corrosion resistance and non-rusting characteristics of copper tube assure trouble-free service and maintenance of traps, valves and other devices. On condensate and hot water return lines, it is recommended that the last *two feet before* the heating medium should be *double* the size of the rest of the line. For example, if the return line is 1-inch tube, enlarge it to 2-inch.

Radiant Panel Heating

A modern application of an ancient principle, radiant panel heating, can be used successfully in nearly all types of structures. In panel systems, low-temperature hot water, circulating through coils or grids of copper tube embedded in a concrete floor or plaster ceiling, warms the surfaces and the air. Panel systems offer uniform heating and comfort, an invisible heat source, complete use of the floor area, cleanliness and the elimination of dust-carrying drafts.

Copper tube is the ideal piping material for floor and ceiling panels because of its excellent heat transfer characteristics, light weight, long lengths, corrosion resistance and ease of bending, joining and handling.



Soft temper tube in coils is commonly used for sinuous (curved pattern) heating layouts, since it is easily bent and joints are reduced to a minimum. Hard temper tube is used for mains, risers, heaters and grid-type heating coils.

Location of the heating panel is relatively unimportant for the comfort of room occupants, but it does depend on the architectural and thermal characteristics of the room. Floor installations have the advantage of low initial cost and are particularly suitable for garages, schools and churches. They are generally designed to operate at a maximum surface temperature of 85°F. Above this temperature, occupants become uncomfortable.

Ceiling panels can be operated at higher surface temperatures and heat output levels than floor panels. Heating panels respond quickly to changes in heating load, have low thermal storage and require only a simple control system.

The tube sizes of heating coils chiefly affect the hydraulics of the heating system and are relatively unimportant from the standpoint of heat output of the panel. For sinuous floor coils 3/8-inch, 1/2-inch and 3/4-inch soft temper tube are generally used with a 9-inch or 12-inch center-to-center spacing. For ceiling panel installations the sinuous coils are formed of 3/8-inch soft temper tube with a tube spacing of 4 inches or 6 inches. Soldered joints are commonly used.

Ground Source Heat Pumps

Air-source heat pumps have been used for residential and commercial heating and cooling for many years. Such units rely on air-to-air heat exchange through evaporator units similar to those used for air conditioners.

More recent heat pump technology relies on circulating a refrigerant through buried copper tubing for heat exchange. These units rely on the constancy of the ground temperature below the frost level (about 55°F) for heat transfer and are considerably more efficient than their air-source counterparts. They are known variously by such terms as ground source, earth-coupled, direct exchange or geothermal.

The most efficient ground source heat pumps use

ACR, Type L or special-size copper tubing buried in the ground to transfer heat to or from the conditioned space. The flexible copper tube (typically 1/4-inch to 5/8-inch) can be buried in deep vertical holes, horizontally in a relatively shallow grid pattern, in a vertical fence-like arrangement in medium-depth trenches, or as custom configurations suited to the installation.

The number of manufacturers which can supply commercial and residential ground source units is constantly growing. Contact the Copper Development Association Inc. to obtain the current listing.

Nonflammable Medical Gas Piping Systems

Safety standards for oxygen and other positive-pressure medical gases require the use of Type K or L copper tube (see **ASTM B 819**). Special cleanliness requirements are called for because oxygen under pressure may cause the spontaneous combustion of some organic oils (the residual of lubricating oil used during manufacture) and for the safety of patients receiving medical gases.

Copper tube for medical gas lines is furnished by the manufacturers suitably cleaned and capped or plugged. Care must be taken to prevent contamination of the system when the caps or plugs are removed and tube is installed. The installer must satisfy himself and the inspection department that the cleanliness requirements of the code have been met.

The following requirements are based on those found in NFPA Standard No. 99, *Health Care Facilities*, Chapter 5, Gas and Vacuum Systems.

Installation and Testing of Medical Gas Piping Systems

1. All piping, valves, fittings and other components for use in all non-flammable medical gas systems must be thoroughly cleaned by the manufacturer to remove oil, grease and other readily oxidizable materials as if they were being prepared for oxygen service. Use

particular care in storage and handling. Such material must be capped or plugged to prevent recontamination before final assembly. Just prior to final assembly, the material must be examined internally for contamination.

- Cleaning must be done in accordance with the provisions of CGA Pamphlet G-4.1, *Cleaning Equipment for Oxygen Service*.
2. All brazed joints in the piping shall be made up using brazing filler metals that bond with the base metals being brazed and that comply with *Specification for Brazing Filler Metal*, ANSI/AWS A5.8.
 - Copper-to-copper joints shall be made using a copper-phosphorus brazing filler metal (BCuP series) without flux.
 - Dissimilar metals such as copper and brass shall be joined using an appropriate flux with either a copper-phosphorus (BCuP series) or a silver (BAG series) brazing filler metal. Apply flux sparingly to the clean tube only and in a manner to avoid leaving any excess inside of completed joints. **(NOTE: Ensure proper ventilation. Some BAG series filler metals contain cadmium, which, when heated during brazing, can produce toxic fumes.)**

- During brazing, the system shall be continuously purged with oil-free dry nitrogen to prevent the formation of scale within the tubing. The purge shall be maintained until the joint is cool to the touch.
 - The outside of all tubes, joints and fittings shall be cleaned by washing with hot water after assembly to remove any excess flux and provide for clear visual inspection of brazed connections.
 - A visual inspection of each brazed joint shall be made to assure that the alloy has flowed completely around the joint at the tube-fitting interface. Where flux has been used, assure that solidified flux residue has not formed a temporary seal that could hold test pressure.
3. Threaded joints in piping systems shall be made up with polytetrafluoroethylene (such as Teflon®) tape or other thread sealants suitable for oxygen service. Sealants shall be applied to the male threads only.

Medical Gas Copper Installation



Medical Gas Copper Installation

To view the online video, please click the image above, scan the QR code, or follow the link: <https://www.youtube.com/watch?v=-XEBR9IHdYU>.





Snow Melting Systems

Snow-melting systems, installed in walks, driveways, loading platforms and other paved areas, are an efficient, economical means of snow, sleet and ice removal. To warm the surface, a 50-50 solution of water and antifreeze is circulated through copper tube embedded in the concrete or blacktop. Considerable savings can be realized at industrial plant installations where waste heat sources can be utilized.

In general, installation of snow melting coils is similar to that of floor panel heating coils. Selection of a sinuous or a grid pattern for a snow-melting system depends largely on the shape, size and installation conditions. Grids are good for square and rectangular areas; sinuous coils are usually preferred for irregular areas. The lower pressure loss with a grid configuration permits the use of smaller diameter tube saving material costs. Maximum economy is often realized with a combination of sinuous and grid-type coils.

Soft temper copper tube is suitable for both sinuous and grid-type coils; hard temper is better for larger grid coils and for mains. Soft tube facilitates the installation of sinuous coils because of its long lengths and ease of bending which reduce the number of joints to a minimum.

The solution temperature entering the snow melting coils should be 120°F to 130°F. To obtain a heating effect for snow melting of 100 BTU per hour per square foot with copper tube spaced on 12-inch centers in concrete (or 9-inch centers in blacktop), a maximum of 140 feet of 1/2-inch tube or 280 feet of 3/4-inch tube may be used. To obtain a heat input of 200 BTU per hour per square foot of snow area, a maximum of 60 feet of 1/2-inch tube or 150 feet of 3/4-inch tube may be used.

Tube in concrete should be located about 1 1/4 to 1 1/2 inches below the surface. The concrete should be reinforced with wire mesh. In blacktop, 1 1/2 inches minimum of compacted thickness of blacktop should cover the tube. The tube should be laid with care on compacted gravel, crushed stone or a concrete base. Allowances should be made for lateral movement where the tube enters and leaves the concrete or blacktop.

The same types of heaters and circulating pumps available for radiant heating installations are suitable for snow-melting panels. The panels also may be hooked up to a building's space heating system, if the system has sufficient capacity for the additional load and satisfactory precautions against freezing can be made.

Irrigation and Agricultural Sprinkler Systems

Irrigation systems are necessities in arid agricultural areas, and sprinkling systems for maintaining landscaped areas are being used increasingly. Regardless of type or size of system, many successful installations testify that copper is the ideal tube material for the lines.

With the aid of pressure loss and velocity relationships shown in **Table 14.6** and the instruction contained in the literature of pump and sprinkler manufacturers, plumbers can lay out a copper tube watering system to service lawns, crops or golf courses.

System lines should be laid deep enough to avoid mechanical damage by tools and they should be pitched to drain freely. Where freezing can be expected, the system should be installed below the frost line.

Expansion and contraction should not be a problem as long as lines are not rigidly anchored.

Solar Energy Systems

Today's focus on energy and resource efficiency as well as sustainable construction has created a global inertia for the use of solar thermal heating and cooling for both space-conditioning and water heating. In many ways, this parallels the national commitment to use solar energy spawned by the energy crises in the 1970s. Solar energy systems to heat domestic water and for space heating are based on adding a collector to the heating system to capture energy from the sun. In general, this simply involves extending the heating/plumbing system to the roof of the house, where a solar collector is incorporated into it.

CDA published **Design Handbook For Solar Energy Systems** which includes an easy-to-use method for properly sizing a solar heating system to achieve desired solar contributions.

Copper is the logical material for solar energy systems because:

- It has the best thermal conductivity of all engineering metals;
- It is highly resistant to both atmospheric and aqueous corrosion;
- It is easy to fabricate and to join by soldering or brazing;
- It has been used both for plumbing and for roofs since metals were first employed in those applications.

Copper's thermal advantages mean thinner copper sheet can collect the same heat as much thicker gages of aluminum or steel sheet, and copper collector tubes can be more widely spaced.

Copper's resistance to atmospheric corrosion is well demonstrated by its service in roofing and flashing. Unless attacked by the sulfur or nitrogen oxide exhausts from utilities or process industries, copper has withstood decades—even centuries—of weathering.

Copper resists hot water corrosion equally well. Properly sized to keep flow rates below those recommended in **Pressure System Sizing**, and properly installed, copper hot water systems are, for all practical purposes, completely resistant to corrosion.

The ease with which copper plumbing systems are joined by soldering needs no special emphasis. Sheet copper fabrication is equally recognized for its ease and simplicity.

Copper-Iron Alloy Tube and Fittings for High Pressure HVAC/R Applications

The air conditioning and refrigeration industry continues to take steps internationally to minimize the potential effects of refrigerant leakage, release and misuse on global warming and ozone depletion, which are increasingly linked to human activity.

To curb the impact on our environment, many refrigerants previously used have been restricted and in some cases banned completely. Refrigerants are being identified with an associated Global Warming Potential (GWP) number. This GWP number compares the global warming potential of the subject refrigerant to the baseline or reference of carbon dioxide, refrigerant R-744, that has a GWP of 1. The higher the GWP number the greater risk that refrigerant poses to global warming. For example, R-22, a previously very common refrigerant has a GWP of 2400. R-134a, a refrigerant developed as a substitute for R-22, has a GWP of 1300 and R-410a, another low-GWP refrigerant, has a GWP of 1725. While much better in terms of GWP than their predecessors, both of these replacement refrigerants still have much greater potential impact than carbon dioxide.

Early refrigeration systems employed two common refrigerants, ammonia and carbon dioxide. Both of these refrigerants proved to be very troublesome in many ways. Ammonia was extremely toxic and caused great concern with respect to human health issues should a leak occur. Carbon dioxide operates at very high pressures (400+ psig in cascade systems to 2,000+ psig at transcritical high-side pressures) with discharge temperatures in the 300°+ range.

Standard copper tube was not suitable for use with ammonia, due to a propensity for corrosion in the presence of ammonia and moisture, and did not provide the strength necessary in economical wall thicknesses to handle the temperatures and pressures at which carbon dioxide systems operate. However, recent advances in copper tube manufacture utilizing a copper alloy (UNS C19400) that contains a small percentage of iron (97% copper minimum, 2.1% – 2.6% iron) has shown great promise in high pressure refrigeration systems, including those utilizing carbon dioxide (CO₂) as well

as other natural refrigerants, see **table below** for the chemical composition of alloy C19400.

Chemical Composition of Copper-Iron Tube and Fittings (Alloy C19400)

	Element				
	Cu	Pb	Zn	Fe	P
Min (%)	97.0		0.05	2.1	0.015
Max (%)		0.03	0.20	2.6	0.15

Copper-iron tube is rated for pressures in the range of 90 Bar (1,305 psi) to 130 Bar (1,885 psi) or more at temperatures up to 300°F. Both copper-iron tube and fittings have been tested and certified as meeting the requirements of *Underwriters Laboratories UL 207 Standard for Refrigerant-Containing Components and Accessories, Nonelectrical*. For additional information related to copper-iron's physical and mechanical characteristics, please review **properties of Alloy C19400**.

In designing a system, tube, fitting and joint ratings must be considered collectively, because the lower of the ratings (tube, fitting or joint) will govern the maximum installation design pressure.

Copper-iron tube and fittings are available in sizes from 3/8" O.D. to 2 1/8" O.D. And the tube is internally cleaned and capped to the requirements of *ASTM B280*. Copper-iron tube is certified for pressure-temperature ratings via a performance standard, not through calculation from dimensional standards. Therefore, the physical properties and dimensions of the tube can vary from manufacturer to manufacturer, except for the outside diameter.

Additional information related to copper-iron tube and fittings can be obtained from the following:

1. **Wieland: K65 Tubes and Fittings**
2. **Mueller Industries: Extra High Performance Copper Tube**

Installation Steps

Copper-iron alloy tube and fittings can be joined using the same brazing techniques and processes utilized for standard plumbing or ACR brazing applications. For brazed joints between tube and fittings manufactured from alloy C19400, which contain phosphorous (P), the use of brazing flux would not be required. However, when joining copper iron tube to other materials, that do not contain phosphorous (P), brazing flux would be required and brazing filler metals meeting the requirements of BAg series brazing alloys are highly recommended. See **Brazed Joints**.

Mechanically Formed Extruded Outlets

Though harder and less malleable than standard copper tube (UNS C12200) copper-iron tube has shown acceptable ability to be drilled and collared per the recommendations shown in **Mechanically Formed Extruded Outlets**. However, it is highly recommended prior to drilling the pilot hole, the tube being drilled to form the tee should be annealed prior to drilling the pilot hole. Pre-annealing of the main tube greatly increases the expected life of the drill head and collaring pins.

General Considerations

It is not possible in a handbook of this type to cover all the variables a plumbing system designer may have to consider. However, in addition to the foregoing discussion, the following information may also prove helpful when preparing job specifications.

Expansion Loops

Copper tube, like all piping materials, expands and contracts with temperature changes. Therefore, in a copper tube system subjected to excessive temperature changes, a long line tends to buckle or bend when it expands unless compensation is built into the system. Severe stresses on the joints may also occur. Such stresses, buckles or bends are prevented by the use of expansion joints or by installing offsets, "U" bends, coil loops or similar arrangements in the tube assembly. These specially shaped tube segments take up expansion and contraction without excessive stress. The expansion of a length of copper tube may be calculated from the formula:

$$\begin{aligned} & \text{Temperature Rise (degrees F)} \\ & \times \text{Length (feet)} \\ & \times 12 \text{ (inches per foot)} \\ & \times \text{Expansion Coefficient (inches per inch per} \\ & \text{degree F)} \\ & = \text{Expansion (inches)} \end{aligned}$$

Calculation for expansion and contraction should be based on the average coefficient of expansion of copper which is 0.0000094 inch per inch per degree F, between 70°F and 212°F. For example, the expansion of each 100 feet of length of any size tube heated from room temperature (70°F) to 170°F (a 100°F rise) is 1.128 inches.

$$\begin{aligned} & 100^\circ\text{F} \times 100 \text{ ft} \times 12 \text{ in./ft.} \\ & \times 0.0000094 \text{ in./in./}^\circ\text{F} \\ & = 1.128 \text{ in.} \end{aligned}$$

Figure 14.2 shows the change in length per 100 feet of copper tube, with temperature. The previous example is shown by the dotted line.

Tables 14.8 gives the radii necessary for coiled expansion loops, described in **Figure 14.3**. Expansion offset lengths may be estimated from **Tables 14.8**.

Alternatively, the necessary length of tube in an expansion loop or offset can be calculated using the formula: where:

$$L = \frac{1}{12} \left(\frac{3E}{P} \right)^{1/2} (d_o e)^{1/2}$$

WHERE:

- L= developed length, in feet, in the expansion loop or offset as shown in **Figure 14.3**
- E=modulus of elasticity of copper, in psi.
- P= design allowable fiber stress of material in flexure, in psi.
- d_o=outside diameter of pipe, in inches.
- e=amount of expansion to be absorbed, in inches.

For annealed copper tube:

- E=17,000,000 psi
- P=6,000 psi

Thus, the developed length L is simply:
L = 7.68 (d_oe)^{1/2}

Tube Supports

Drawn temper tube, because of its rigidity, is preferred for exposed piping. Unless otherwise stated in plumbing codes, drawn temper tube requires support for horizontal lines at about 8-foot intervals for sizes of 1-inch and smaller, and at about 10-foot intervals for larger sizes.

Vertical lines are usually supported at every story or at about 10-foot intervals, but for long lines where there are the usual provisions for expansion and contraction, anchors may be several stories apart, provided there are sleeves or similar devices at all intermediate floors to restrain lateral movement, see **Figure 3.1**.

Annealed temper tube in coils permits long runs without intermediate joints. Vertical lines of annealed temper tube should be supported at least every 10 feet. Horizontal lines should be supported at least every 8 feet.



Resistance to Crushing

Tests made by placing a 3/4 -inch round steel bar at right angles across a 1-inch annealed copper tube and then exerting pressure downward revealed that, even with this severe point-contact loading, 700 pounds were required to crush the tube to 75 percent of its original diameter. Two-inch sizes, because of their greater wall thicknesses, resisted even more weight before crushing.

Plumbing codes and good piping practice require that all excavations shall be completely backfilled as soon after inspection as practical. Trenches should first be backfilled with 12 inches of tamped, clean earth which should not contain stones, cinders or other materials which would damage the tube or cause corrosion. Equipment such as bulldozers and graders may be used to complete backfilling. Suitable precautions should be taken to ensure permanent stability for tube laid in fresh ground fill.

Water Hammer

Water hammer is the term used to describe the destructive forces, pounding noises and vibrations which develop in a water system when the flowing liquid is stopped abruptly by a closing valve.

When water hammer occurs, a high-pressure shock wave reverberates within the piping system until the energy has been spent in frictional losses. The noise of such excessive pressure surges may be prevented by adding a capped air chamber or surge arresting device to the system.

Arresting devices are available commercially to provide permanent protection against shock from water hammer. They are designed so the water in the system will not contact the air cushion in the arrester and, once installed, they require no further maintenance.

On single-fixture branch lines, the arrester should be placed immediately upstream from the fixture valve. On multiple-fixture branch lines, the preferred location for the arrester is on the branch line supplying the fixture group between the last two fixture supply pipes.

Collapse Pressure of Copper Tube

The constantly increasing use of copper and copper alloy tube in condensers, water heaters and other heat transfer devices for water, gas and fluid lines, and many other engineering applications where a pressure differential exists on opposite sides of the tube wall, makes accurate data necessary regarding collapse pressures. See **Figure 14.1**.

Freezing

Annealed temper tube can withstand the expansion of freezing water several times before bursting. Under testing, the water filling a 1/2-inch soft tube has been frozen as many as six times, and a 2-inch size, eleven times. This is a vital safety factor favoring soft tube for underground water services. However, it does not mean that copper water tube lines should be subjected to freezing.

Corrosion

Copper water tube is corrosion resistant. It is very infrequent that waters or special conditions are encountered which can be corrosive to copper tube. When they are encountered, they should be recognized and dealt with accordingly.

Since World War II, over 18 billion pounds of copper plumbing tube has been produced in the United States, 80% of which has been installed in water distribution systems. This translates into more than 7 million miles of copper tube. The rare problems of corrosion by aggressive water, possibly aggravated by faulty design or workmanship, should be viewed in the context of this total record of outstanding service performance. In general, widespread use of copper plumbing tube in a locality can be taken as good evidence that the water there is not aggressive to copper.

When corrosion problems do occur, they usually stem from one of the following causes:

1. aggressive, hard well waters that cause pitting;
2. soft, acidic waters that do not allow a protective film to form inside the copper tube;

3. system design or installation which results in excessive water flow velocity or turbulence in the tube;
4. unacceptable workmanship;
5. excessive or aggressive flux;
6. aggressive soil conditions.

Aggressive pitting waters can be identified by chemical analysis and treated to bring their composition within acceptable limits. Characteristically, they have high total dissolved solids (t.d.s.) including sulfates and chlorides, a pH in the range of 7.2 to 7.8, a high content of carbon dioxide (CO₂) gas (over 10 parts per million, ppm), and the presence of dissolved oxygen (D.O.) gas.

A qualified water treatment professional can specify a treatment for any aggressive water to make it non-aggressive to plumbing materials. In general, this involves raising the pH and combining or eliminating the CO₂ gas. Sometimes simple aeration of the water (e.g., spraying in the open air) is treatment enough.

Pitting can also be caused or intensified by faulty workmanship which leaves excessive amounts of residual aggressive flux inside the tube after installation. If the joints have been overheated during installation and the excess residual flux has polymerized, the pitting problem can worsen.

Soft acidic waters can cause the annoying problem of green staining of fixtures or "green water." Raising the pH of such waters to a value of about 7.2 or more usually solves the problem, but a qualified water treatment professional should be consulted. A typical treatment for an individual well water supply is to have the water flow through a bed of marble or limestone chips.

Excessive water velocity may contribute to erosion-corrosion or impingement attack in plumbing systems. As explained in the discussion of **Pressure System Sizing**, to avoid erosion-corrosion (and noise) problems, the water velocity in a plumbing system should not exceed 5 to 8 feet per second—the lower limit applying to smaller tube sizes.

Velocity effects can be aggravated if the water is chemically aggressive due to pH or gas content as outlined above, or if solids (silt) are entrained in the

flow. The combination of a velocity that is otherwise acceptable and a water chemistry that is somewhat aggressive can sometimes cause trouble that would not result from either factor by itself.

Erosion-corrosion can also be aggravated by faulty workmanship. For example, burrs left at cut tube ends can upset smooth water flow, cause localized turbulence and high flow velocities, resulting in erosion-corrosion.

Any metal pipe laid in cinders is subject to attack by the acid generated when sulfur compounds in the cinders combine with water. Under such circumstances, the tube should be isolated from the cinders with an inert moisture barrier, a wrapping of insulating tape, a coating of an asphaltum paint, or with some other approved material. With rare exception, natural soils do not attack copper.

Copper drainage tube rarely corrodes, except when misused or when errors have been made in designing or installing the drainage system. An improper horizontal slope can create a situation where corrosive solutions could lie in the tube and attack it. If hydrogen sulfide gas in large volume is allowed to vent back into the house drainage system, it can attack the tube.

Vibration

Copper tube can withstand the effects of vibration when careful consideration is given to the system design.

Care should be taken when installing systems subject to vibration to assure that they are free from residual stresses due to bending or misalignment. Residual stresses coupled with vibration can cause fatigue at bends and connections where such residual stresses have been built into the system.

Durability

Under normal conditions, a correctly designed and properly installed copper water tube assembly will easily last the life of the building. Throughout its existence, the assembly should function as well as it did when originally installed.



Certification to NSF/ANSI Standards

The U.S. Safe Drinking Water Act (SDWA) and the Lead and Copper Rule require public water suppliers to provide non-corrosive drinking water to customers. Typically, this is accomplished through the use of pH adjustment (pH 6.5 to 8.5) and through the addition of corrosion inhibitors such as ortho- and polyphosphates. The resultant tap water concentrations of lead and copper must be below the action levels of 15µg/L and 1300µg/L, respectively.

NSF International developed third party, consensus American national public health standards for chemicals used to treat drinking water (NSF/ANSI 60) and products coming into contact with drinking water (NSF/ANSI 61). NSF/ANSI 61: Drinking Water System Components – Health Effects was developed to establish minimum requirements for the control of potential adverse human health effects from products that contact drinking water, but does not attempt to include product performance requirements beyond the health effects. This standard replaced the USEPA Additives Advisory Program for drinking water system components and in April of 1990 USEPA terminated its own advisory role.

Copper tube and fittings manufacturers certify their products to NSF/ANSI 61, the nationally recognized health effects standard for all devices, components and materials that come in contact with drinking water. All have the limitations of being certified for use in non-corrosive aqueous environments. Specifically, the pH must not be below 6.5. Otherwise, resultant copper concentrations in tap water may exceed the action level established by the EPA.

NSF/ANSI Standard 61 requires products evaluated to conditions other than those specified in the standard (such as pH 5.0 and 10.0 exposure water) to be labeled with a limitation statement, as follows:

Copper tube (Alloy C12200) has been evaluated by {certified testing agency such as NSF, UL, IAPMO, WQA, CSA...} to NSF/ANSI 61 for use in drinking water supplies of pH 6.5 and above. Drinking water supplies that are less than pH 6.5 may require corrosion control to limit leaching of copper into the drinking water.

Certified copper tube and fittings must bear the certification mark and the above use limitation statement. The length of the limitation statement makes it difficult to place on the tube and fittings themselves. Additionally, current inking technology results in smearing and low legibility. For these reasons, NSF certification policies allow copper tube manufacturers to place the limitation statement on a tag attached to bundles of copper tube or on the boxes of coiled copper tube. All copper tube and fittings that have been certified to meet NSF/ANSI 61 will carry an appropriate certification mark. In the case of copper tube, this usually means the inclusion of “NSF 61” within the required ink-marking on the tube.

Lead Content Compliance

On January 4, 2014, the Safe Drinking Water Act as amended went into effect requiring drinking water products sold or installed for use in public water systems and plumbing in facilities, to meet a weighted average of not more than 0.25 percent lead with respect to the wetted surfaces of pipes, pipe fittings, plumbing fittings, and fixtures. Third-party certification of these products to the new lead-free requirements will be required in many jurisdictions. Additionally, the states of California, Vermont, Maryland and Louisiana have already instituted these requirements for products currently in the market. Products meeting this requirement may be marked with NSF/ANSI 61-G, NSF/ANSI 372 or NSF® 372.

Copper tube and fittings are certified to the new lead content standards and bear the appropriate certification marks. This was not a difficult test for copper tube and fittings manufacturers because lead has never been a component in their products.

WORKING WITH COPPER TUBE

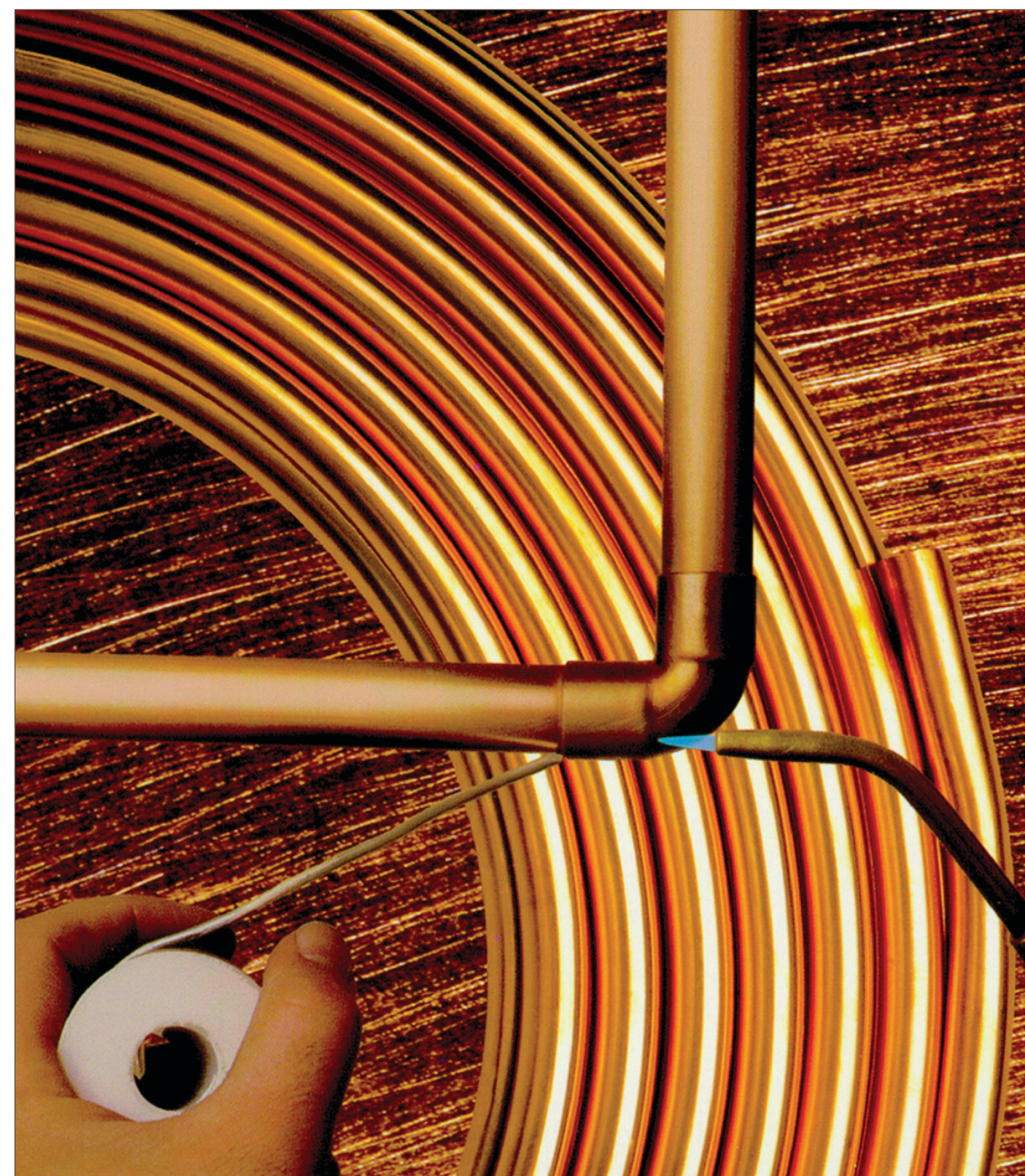

4. BENDING

Because of its exceptional formability, copper can be formed as desired at the job site. Copper tube, properly bent, will not collapse on the outside of the bend and will not buckle on the inside of the bend. Tests demonstrate that the bursting strength of a bent copper tube can actually be greater than it was before bending.

Because copper is readily formed, expansion loops and other bends necessary in an assembly are quickly and simply made if the proper method and equipment are used. Simple hand tools employing mandrels, dies, forms and fillers, or power-operated bending machines can be used.

Both annealed tube and hard drawn tube can be bent with the appropriate hand benders. The proper size of bender for each size tube must be used. For a guide to typical bend radii, see **Table 4.1**.

The procedure for bending copper tube with a lever-type hand bender is illustrated in **Figure 4.1** below.

TABLE 4.1. Bending Guide for Copper Tube

Nominal Standard Size, in	Tube Type	Temper	Minimum Bend, Radius*, in
1/4	K,L	Annealed	3/4
3/8	K,L	Annealed	1 1/2
	K,L,M	Drawn	1 3/4
1/2	K,L	Annealed	2 1/4
	K,L,M	Drawn	2 1/2
3/4	K,L	Annealed	3
	K,L	Drawn	3
1	K,L	Annealed	4
1 1/4	K,L	Annealed	9

* The radii stated are the minimums for mechanical bending equipment only.

Bending Copper Tube



Bending Copper Tube

To view the online video, please click the image above, scan the QR code, or follow the link: <https://www.youtube.com/watch?v=fOAYyp32PL0>.

Figure 4.1. Bending Using a Lever-Type Hand Bender (tool shown is appropriate for use with annealed tube only)

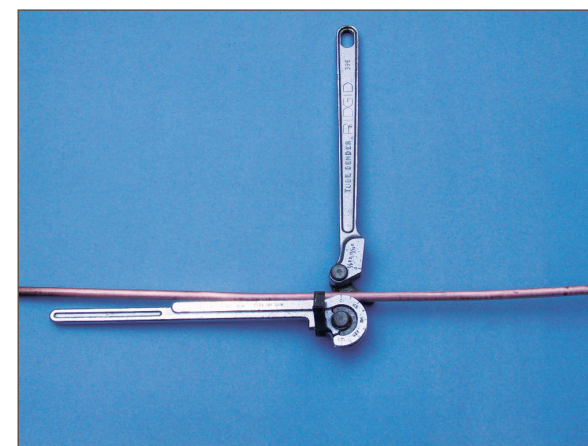

(A) With the handles of the tube bender at 90 degrees insert the tube into the forming wheel groove with the mark for the center-of-bend aligned with the “0” on the forming handle. Engage the tube holding clip to secure the tube to the bender at the appropriate location for bending.

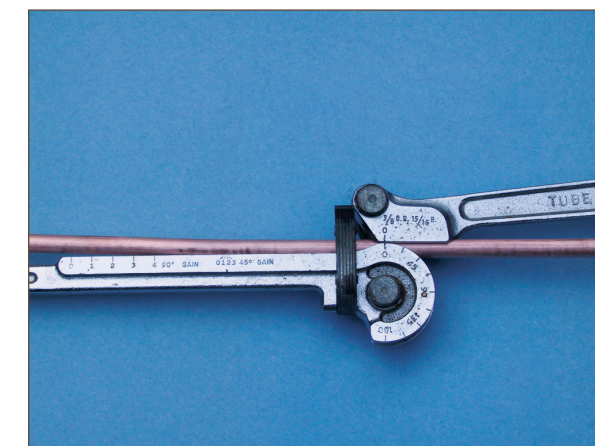

(B) Rotate the handle to the position shown. The “0” on the handle must align with the “0” on the forming wheel before any bend pressure is applied to the bending handle. Apply gentle but steady pressure on the handle and rotate it to the appropriate degree marking on the forming wheel for the desired degree of bend.

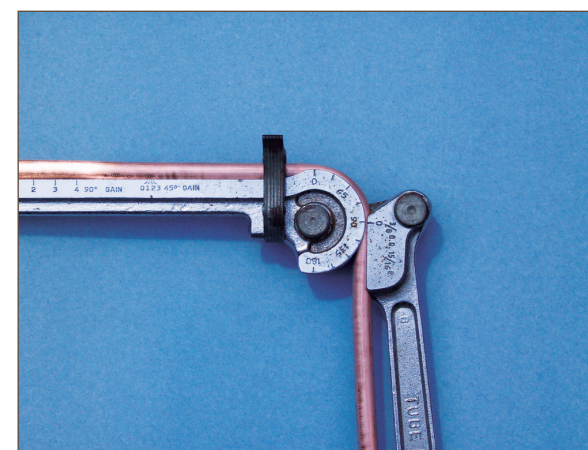

(C) Once the appropriate degree of bend is reached, as identified by the degree mark on the forming wheel, the bend is completed. The properly bent tube can be removed from the bender by rotating the handle back to the 90 degree position as shown in **(A)**, disengage the holding clip and remove the tube from the bender.

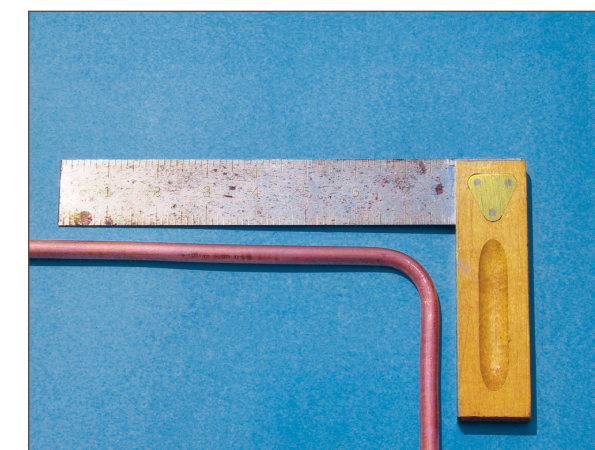

(D) To ensure the proper degree of desired bend has been fabricated the bend should be checked against a square or other appropriate tool. (A square is shown here confirming the 90 degree bend.)

The tool illustrated is just one of many available to the industry. Of course, if the manufacturer of the tube bender has special instructions regarding his product, such instructions should be followed.



5. JOINING METHODS

There are several categories of methods to join copper tube and fittings:

Solder or Brazed Joints

These joining methods include **soldering**, **brazing** and electric resistance. Soldered joints, with capillary fittings, are used in plumbing for water lines and for sanitary drainage. Brazed joints, with capillary fittings, are used where greater joint strength is required or where service temperatures are as high as 350°F.

Brazing is preferred, and often required, for joints in air-conditioning and refrigeration piping. Electric resistance joining is a flameless way to make soldered joints, although heat is still generated.

Pressure-temperature ratings for soldered and brazed joints are found in **Table 14.4a**. More information about soldered and brazed joints can be found in **Fittings, Solders and Fluxes** section.

Copper tube may also be joined by butt-welding without the use of fittings. Care must be taken to use proper welding techniques. Welding methods are covered in CDA publication A1050, *Welding Copper and Copper Alloys*.

No-flame Joints

Flameless mechanical joining methods have been used for decades for underground tubing, for joints where the use of heat is impractical and for joints that may have to be disconnected from time to time. Traditional methods include **Flared Joints** and **Roll Groove** coupling systems.

Newer methods for most general plumbing applications include solderless **Press-connect** and **Push-connect** fittings, which incorporate an elastomeric gasket or seal (such as EPDM). The ranges of pressure-temperature ratings for no-flame joints are found in **Table 14.4b**.

Additional Joining Methods

Mechanically Formed Extruded Outlets or tee-pulling is typically used in a variety of plumbing and piping applications where tee-connections are frequently encountered. Tee-pulling is a mechanical process; however, it requires a brazed joint for completion. *Soldering of the branch tubing into the mechanically formed tee is not permitted.*



6. FITTINGS, SOLDERS, FLUXES

Fittings

Fittings for copper water tube used in plumbing and heating are made to the following standards:

- *Cast Copper Alloy Threaded Fittings* (ASME B16.15)
- *Cast Copper Alloy Solder Joint Pressure Fittings* (ASME B16.18)
- *Wrought Copper and Copper Alloy Solder Joint Pressure Fittings* (ASME B16.22)
- *Wrought Copper LW Solder Joint Pressure Fittings* (MSS SP104)
- *Welded Fabricated Copper Solder Joint Pressure Fittings* (MSS SP109)
- *Cast Copper Alloy Solder Joint Drainage Fittings DWV* (ASME B16.23)
- *Bronze Pipe Flanges and Flanged Fittings* (ASME B16.24)
- *Cast Copper Alloy Fittings for Flared Copper Tubes* (ASME B16.26)
- *Wrought Copper and Wrought Copper-Alloy Solder Joint Drainage Fittings DWV* (ASME B16.29)
- *Wrought Copper and Copper Alloy Braze-Joint Pressure Fittings* (ASME B16.50)
- *Removable and Non-Removable Push-Fit Fittings* (ASSE 1061)

Examples of solder joint end dimensions are shown in **Figure 14.5**.

Cast alloy pressure fittings are available in all standard tube sizes and in a limited variety of types to cover needs for plumbing and mechanical systems. They can be either soldered or brazed, although brazing cast fittings requires care. Wrought copper pressure fittings are available over a wide range of sizes and types. These, too, can be joined by either soldering or brazing; wrought fittings are preferred where

brazing is the joining method. Otherwise, the choice between cast and wrought fittings is largely a matter of the user's preference and availability.

Flared-tube fittings provide metal-to-metal contact similar to ground joint unions; both can be easily taken apart and reassembled. They are especially useful where residual water cannot be removed from the tube and soldering is difficult. Flared joints may be required where a fire hazard exists and the use of a torch to make soldered or brazed joints is not allowed.

Soldering under wet conditions can be very difficult; flared, press-, and push-connect joints are preferred under such circumstances.

Solders

Soldered joints depend on capillary action drawing free-flowing molten solder into the gap between the fitting and the tube. Flux acts as a wetting agent and, when properly applied, permits uniform spreading of the molten solder over the surfaces to be joined.

The selection of a solder depends primarily on the operating pressure and temperature of the system. Consideration should also be given to the stresses on joints caused by thermal expansion and contraction. However, this may not be necessary when a tube length is short or when an expansion loop is used in a long tube run. In such cases, the stresses caused by a temperature change are usually insignificant.

Rated internal working pressures for solder joints made with copper tube using 50-50 tin-lead solder (ASTM B32 Alloy Sn50), 95-5 tin-antimony solder (ASTM B32 Alloy Sb5), and several lead-free solders (ASTM B32 Alloy E and Alloy HB) are listed in **Tables 14.3a-e**.

The 50-50 tin-lead solder is suitable for moderate pressures and temperatures. For higher pressures, or where greater joint strength is required, 95-5 tin-antimony solder and alloys E and HB can be used. For continuous operation at temperatures exceeding



250°F, or where the highest joint strength is required, brazing filler metals should be used (see **Table 14.4a**).

Solder alloys listed in Section 1 of Table 1 Solder Compositions in ASTM B32, *Standard Specification for Solder Metal*, can be used to join copper tube and fittings in potable water systems. **Solders containing lead at concentrations of greater than 0.2% are banned for potable water systems by the 1986 amendment to the Federal Safe Drinking Water Act (SDWA).** Some state and local jurisdictions may allow the use of 50-50 tin-lead solder in some HVAC, drainage and other piping system applications.

Fluxes

The functions of soldering flux are to protect against re-oxidation of the joint during the soldering procedure, promote wetting that allows capillary action to begin, and to assist in residual oxide removal. The flux should be applied to surfaces that have been mechanically cleaned, and only enough should be used to lightly coat the areas on the tube and fitting that are to be joined.

An oxide film may re-form quickly on copper after it has been cleaned. Therefore, the flux should be applied as soon as possible after cleaning.

The fluxes best suited for soldering copper and copper alloy tube should meet the requirements of ASTM B 813, *Standard Specification for Liquid and Paste Fluxes for Soldering Applications of Copper and Copper Alloy Tube*.

Some fluxes identified by their manufacturers as "self-cleaning" present a risk in their use. There is no doubt that a strong, corrosive flux can remove some oxides and dirt films. However, when highly corrosive fluxes are used this way, there is always uncertainty whether uniform cleaning has been achieved and whether corrosive action from flux residue continues after the soldering has been completed.

7. SOLDERED JOINTS

The American Welding Society defines soldering as "a group of joining processes that produce coalescence of materials by heating them to a soldering temperature and by using a filler metal (solder) having a liquidus not exceeding 840°F and below the solidus of the base metals." In actual practice, most soldering is done at temperatures from about 350°F to 600°F.

To consistently make satisfactory joints, the following sequence of joint preparation and operations, based on ASTM Standard Practice B 828, should be followed:

- **Measuring and Cutting**
- **Reaming**
- **Cleaning**
- **Applying Flux**
- **Assembly and Support**
- **Heating**
- **Applying Solder**
- **Cooling and Cleaning**
- **Testing**

The techniques described produce leak-tight soldered joints between copper and copper alloy tube and fittings, either in shop operations or in the field. Skill and knowledge are required to produce a satisfactorily soldered joint.

Measuring and Cutting

Accurately measure the length of each tube segment (**Figure 7.1**). Inaccuracy can compromise joint quality. If the tube is too short, it will not reach all the way into the cup of the fitting and a proper joint cannot be made. If the tube segment is too long, system strain may be introduced which could affect service life.

Cut the tube to the measured lengths. Cutting can be accomplished in a number of different ways to produce a satisfactory squared end. The tube can be cut with a disc-type tube cutter (**Figure 7.2**), a hacksaw, an abrasive wheel, or with a stationary or portable band saw. Care must be taken that the tube is not deformed while being cut. Regardless of method, the cut must be square to the run of the tube so that the tube will seat properly in the fitting cup.



Figure 7.1. Measuring



Figure 7.2. Cutting



Reaming

Ream all cut tube ends to the full inside diameter of the tube to remove the small burr created by the cutting operation. If this rough, inside edge is not removed by reaming, erosion-corrosion may occur due to local turbulence and increased local flow velocity in the tube. A properly reamed piece of tube provides a smooth surface for better flow.

Remove any burrs on the outside of the tube ends, created by the cutting operation, to ensure proper entrance of the tube into the fitting cup.

Tools used to ream tube ends include half-round or round files (Figure 7.3), a pocket knife (Figure 7.4), and a suitable deburring tool (Figure 7.5). With soft tube, care must be taken not to deform the tube end by applying too much pressure.

Soft temper tube, if deformed, can be brought back to roundness with a sizing tool. This tool consists of a plug and sizing collar.



Figure 7.3. Reaming: File



Figure 7.4. Reaming: Pocket Knife

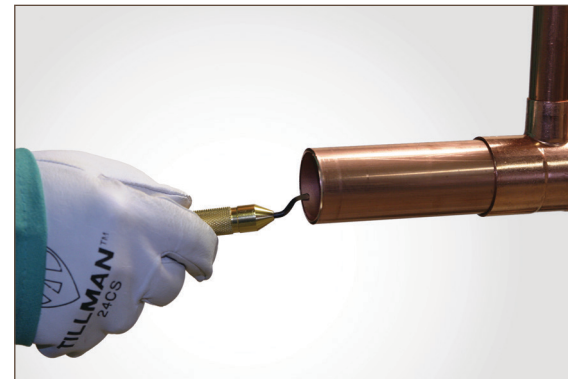

Figure 7.5. Reaming: Deburring Tool

Cleaning

The removal of all oxides and surface soil from the tube ends and fitting cups is crucial to proper flow of solder metal into the joint. Failure to remove them can interfere with capillary action and may lessen the strength of the joint and cause failure.

Lightly abrade (clean) the tube ends using sand cloth (Figure 7.6) or nylon abrasive pads (Figure 7.7) for a distance slightly more than the depth of the fitting cups.

Clean the fitting cups by using abrasive cloth, abrasive pads or a properly sized fitting brush (Figure 7.8).

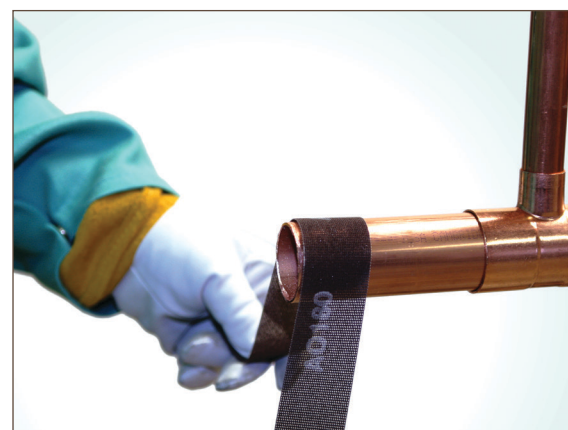

Figure 7.6. Cleaning: Sand Cloth

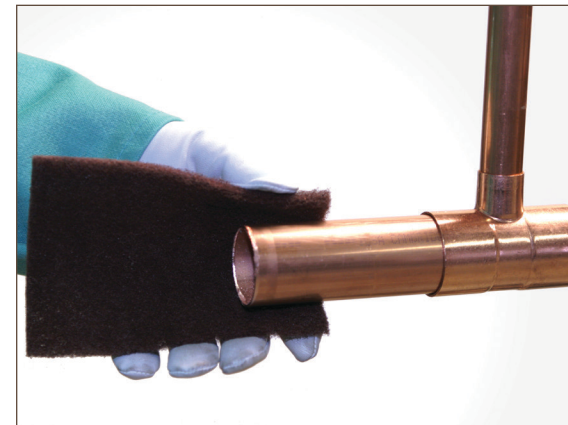

Figure 7.7. Cleaning: Abrasive Pad



Figure 7.8. Cleaning: Fitting Brush

The capillary space between tube and fitting is approximately 0.004 in. Solder metal fills this gap by capillary action. This spacing is critical for the solder metal to flow into the gap and form a strong joint.

Copper is a relatively soft metal. If too much material is removed from the tube end or fitting cup, a loose fit may result in a poor joint.

Chemical cleaning may be used if the tube ends and fittings are thoroughly rinsed after cleaning according to the procedure furnished by the cleaner manufacturer. Do not touch the cleaned surface with bare hands or oily gloves. Skin oils, lubricating oils and grease impair the soldering operation.

Applying Flux

Use a flux that will dissolve and remove traces of oxide from the cleaned surfaces to be joined, protect the cleaned surfaces from reoxidation during heating, and promote wetting of the surfaces by the solder metal, as recommended in the general requirements of ASTM B 813. Apply a thin even coating of flux with a brush to both tube and fitting as soon as possible after cleaning (Figures 7.9 and 7.10).



Figure 7.9. Fluxing: Tube



Figure 7.10. Fluxing: Fitting

WARNING: Do not apply with fingers. Chemicals in the flux can be harmful if carried to the eyes, mouth or open cuts. Use care in applying flux. Careless workmanship can cause problems long after the system has been installed. If excessive amounts of flux are used, the flux residue can cause corrosion. In extreme cases, such flux corrosion could perforate the wall of the tube, fitting or both.

Assembly and Support

Insert the tube end into fitting cup, making sure that the tube is seated against the base of the fitting cup (**Figure 7.11**). A slight twisting motion ensures even coverage by the flux. Remove excess flux from the exterior of the joint with a cotton rag (**Figure 7.12**).

Support the tube and fitting assembly to ensure a uniform capillary space around the entire circumference of the joint. Uniformity of capillary space will ensure good capillary flow (**Figure 7.18**), of the molten-solder metal. Excessive joint clearance can lead to solder metal cracking under conditions of stress or vibration.

The joint is now ready for soldering. Joints prepared and ready for soldering must be completed the same day and not left unfinished overnight.



Figure 7.11. Assembly



Figure 7.12. Removing Excess Flux

Heating

WARNING: When dealing with an open flame, high temperatures and flammable gases, safety precautions must be observed as described in ANSI/AWS Z49.1.

Begin heating with the flame perpendicular to the tube (**Figure 7.18**, position 1 and **Figure 7.13**). The copper tube conducts the initial heat into the fitting cup for even distribution of heat in the joint area. The extent of this preheating depends upon the size of the joint. Preheating of the assembly should include the entire circumference of the tube in order to bring the entire assembly up to a suitable preheat condition. However, for joints in the horizontal position, avoid directly preheating the top of the joint to avoid burning the soldering flux. The natural tendency for heat to rise will ensure adequate preheat of the top of the assembly. Experience will indicate the amount of heat and the time needed.

Next, move the flame onto the fitting cup (**Figure 7.18**, position 2 and **Figure 7.14**). Sweep the flame alternately between the fitting cup and the tube a distance equal to the depth of the fitting cup (**Figure 7.18**, position 3). Again, preheating the circumference of the assembly as described above, with the torch at the base of the fitting cup (**Figure 7.18**, position 4), touch the solder to the joint. If the solder does not melt, remove it and continue heating.

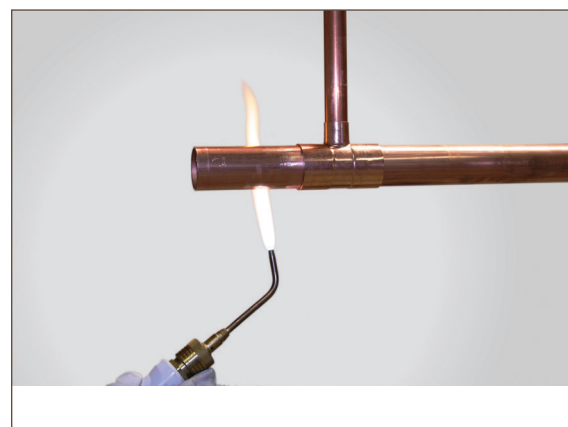

Figure 7.13. Preheating Tube



Figure 7.14. Preheating Fitting

CAUTION: Do not overheat the joint or direct the flame into the face of the fitting cup. Overheating could burn the flux, which will destroy its effectiveness and the solder will not enter the joint properly.

When the solder melts, apply heat to the base of the cup to aid capillary action in drawing the molten solder into the cup towards the heat source.

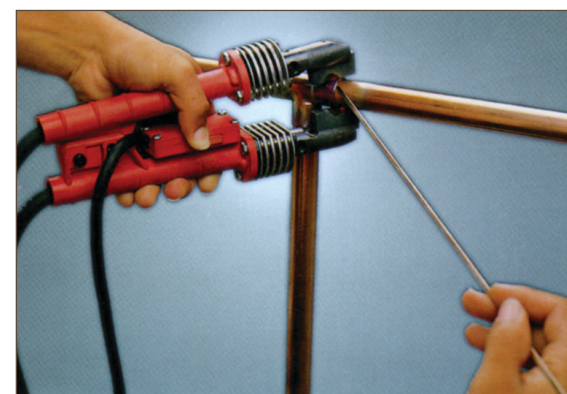

Figure 7.15. Electric Resistance Hand Tool

The heat is generally applied using an air-fuel torch. Such torches use acetylene or an LP gas. Electric resistance soldering tools can also be used (**Figure 7.15** above). They employ heating electrodes and should be considered when an open flame is a concern.

Applying Solder

For joints in the horizontal position, start applying the solder metal slightly off-center at the bottom of the joint (**Figure 7.18**, position a, and **Figure 7.16**). When the solder begins to melt from the heat of the tube and fitting, push the solder straight into the joint while keeping the torch at the base of the fitting and slightly ahead of the point of application of the solder. Continue this technique across the bottom of the fitting and up one side to the top of the fitting (**Figure 7.18**, position b).

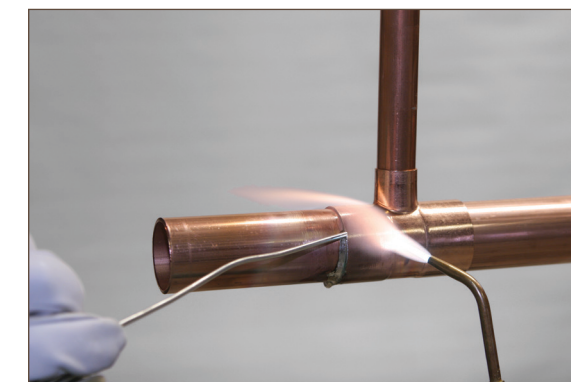

Figure 7.16. Soldering

The now-solidified solder at the bottom of the joint has created an effective dam that will prevent the solder from running out of the joint as the side and top of the joint are being filled.

Return to the point of beginning, overlapping slightly (**Figure 7.18**, position c), and proceed up the uncompleted side to the top, again, overlapping slightly (**Figure 7.18**, position d). While soldering, small drops may appear behind the point of solder application, indicating the joint is full to that point and will take no more solder. Throughout this process you are using all three physical states of the solder: solid, pasty and liquid.

For joints in the vertical position, make a similar sequence of overlapping passes starting wherever is convenient.

Solder joints depend on capillary action drawing free-flowing molten solder into the narrow clearance between the fitting and the tube. Molten solder metal is drawn into the joint by capillary action regardless of whether the solder flow is upward, downward or horizontal.



Capillary action is most effective when the space between surfaces to be joined is between 0.004 inch and 0.006 inch. A certain amount of looseness of fit can be tolerated, but too loose a fit can cause difficulties with larger size fittings.

For joining copper tube to solder-cup valves, follow the manufacturer's instructions. The valve should be in a partially open position before applying heat, and the heat should be applied primarily to the tube. Commercially available heat-sink materials can also be used for protection of temperature-sensitive components during the joining operation.

The amount of solder consumed when adequately filling the capillary space between the tube and either wrought or cast fittings may be estimated from **Table 14.10**. The flux requirement is usually 2 ounces per pound of solder.

Cooling and Cleaning

Allow the completed joint to cool naturally. Shock cooling with water may stress the joint. When cool, clean off any remaining flux residue with a wet rag (**Figure 7.17**). Whenever possible, based on end use, completed systems should be flushed to remove excess flux and debris.



Figure 7.17. Cleaning

Testing

Test all completed assemblies for joint integrity. Follow the testing procedure prescribed by applicable codes governing the intended service.

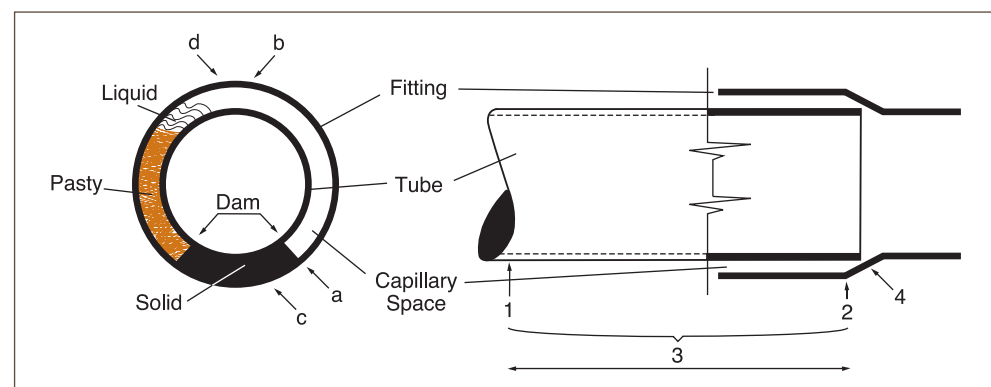

Figure 7.18. Schematic of Solder Joint

Soldering Preparation



Soldering Preparation

To view the online video, please click the image above, scan the QR code, or follow the link: <https://www.youtube.com/watch?v=Js7EmUmN8cg>.

Fluxing & Soldering Techniques



Fluxing & Soldering Techniques

To view the online video, please click the image above, scan the QR code, or follow the link: <https://www.youtube.com/watch?v=RwKdMkkkhqo>.

Soldering and Brazing Copper Alloy Flanges



Soldering and Brazing Copper Alloy Flanges

To view the online video, please click the image above, scan the QR code, or follow the link: <https://www.youtube.com/watch?v=v6zuSsrnaTY>.

Soldering of No-Lead Copper Alloy Fittings, Valves & Components



Soldering of No-Lead Copper Alloy Fittings, Valves & Components

To view the online video, please click the image above, scan the QR code, or follow the link: https://www.youtube.com/watch?v=nyGZl48_vuc.



8. BRAZED JOINTS

Strong, leak-tight brazed connections for copper tube may be made by brazing with filler metals which melt at temperatures in the range between 1100°F and 1500°F, as listed in **Table 14.12**. Brazing filler metals are sometimes referred to as "hard solders" or "silver solders." **These confusing terms should be avoided.**

The temperature at which a filler metal starts to melt on heating is the *solidus* temperature; the *liquidus* temperature is the higher temperature at which the filler metal is completely melted. The *liquidus* temperature is the minimum temperature at which brazing will take place.

The difference between *solidus* and *liquidus* is the *melting range* and may be of importance when selecting a filler metal. It indicates the width of the working range for the filler metal and the speed with which the filler metal will become fully solid after brazing. Filler metals with narrow ranges, with or without silver, solidify more quickly and, therefore, require careful application of heat. The melting ranges of common brazing metals are shown in **Figure 14.7**.

Brazing Filler Metals

Brazing filler metals suitable for joining copper tube are of two classes:

1. the BCuP series alloys containing phosphorus
2. the BAg series alloys containing a high silver content

The two classes differ in their melting, fluxing and flowing characteristics and this should be considered in selection of a filler metal (See **Table 14.12**.) While any of the listed filler metals may be used, those most commonly used in plumbing, HVAC refrigeration and fire sprinkler systems are BCuP-2 (for closer tolerances), BCuP-3, 4 or 5 (where close tolerances cannot be held) and BAg-1, BAg-5 and BAg-7. The BCuP series filler metals are more economical than the BAg series, and are

better suited for general piping applications. BAg series filler metals should be used when joining dissimilar metals, or the specific characteristics of the BAg series filler metals are required. For joining copper tube, any of these filler metals will provide the necessary strength when used with standard solder-type fittings or commercially available short-cup brazing fittings.

According to the American Welding Society (AWS), the strength of the brazed joint will meet or exceed that of the tube and fitting being joined when the joint overlap and the depth of the filler metal penetration is a minimum of three times the thickness of the thinner base metal (tube or fitting), and a well-developed fillet is present.

The strength of a brazed copper tube joint does not vary much with the different filler metals but depends mainly on maintaining the proper clearance between the outside of the tube and the cup of the fitting. Copper tube and solder-type fittings are accurately made for each other, and the tolerances permitted for each assure the capillary space will be within the limits necessary for a joint of satisfactory strength.

The rated internal working pressures of brazed copper tube systems at service temperatures up to 350° F (the temperature of saturated steam at 120 psi) are shown in **Table 14.4a**. These pressure ratings should be used only when the correct capillary space has been maintained.

Fluxes

The fluxes used for brazing copper joints are different in composition from soldering fluxes. The two types cannot be used interchangeably.

Unlike soldering fluxes, brazing fluxes are water based. Similar to soldering fluxes, brazing fluxes dissolve and remove residual oxides from the metal surface, protect the metal from reoxidation during heating and promote wetting of the surfaces to be joined by the brazing filler metal.

Brazing fluxes also provide the craftsman with an indication of temperature (**Figure 14.6b**). If the outside of the fitting and the heat-affected area of the tube are covered with flux (in addition to the end of the tube and the cup), oxidation will be minimized and the appearance of the joint will be greatly improved.

The fluxes best suited for brazing copper and copper alloy tube should meet AWS Standard A5.31, Type FB3-A or FB3-C.

Figure 14.7 illustrates the need for brazing flux with different types of copper and copper-alloy tube, fittings and filler metals when brazing.

Assembly

Assemble the joint by inserting the tube into the socket hard against the stop and turn if possible. The assembly should be firmly supported so that it will remain in alignment during the brazing operation.

Applying Heat and Brazing

Apply heat to the parts to be joined, preferably with an oxy-fuel torch with a neutral flame. Air-fuel is sometimes used on smaller sizes. Heat the tube first, beginning about one inch from the edge of the fitting, sweeping the flame around the tube in short strokes at right angles to the axis of the tube (**Figure 7.18**, position 1).

It is very important that the flame be in motion and not remain on any one point long enough to damage the tube. The flux may be used as a guide as to how long to heat the tube. The behavior of flux during the brazing cycle is described in **Figure 14.6**.

Switch the flame to the fitting at the base of the cup (**Figure 7.18**, position 2). Heat uniformly, sweeping the flame from the fitting to the tube until the flux on the fitting becomes quiet. Avoid excessive heating of cast fittings, due to the possibility of cracking.

When the flux appears liquid and transparent, start sweeping the flame back and forth along the axis of the joint to maintain heat on the parts to be joined, especially toward the base of the cup of the fitting (**Figure 7.18**, position 3). The flame must be kept

moving to avoid melting the tube or fitting.

For 1-inch tube and larger, it may be difficult to bring the whole joint up to temperature at one time. It frequently will be found desirable to use an oxy-fuel, multiple-orifice heating tip to maintain a more uniform temperature over large areas. A mild preheating of the entire fitting is recommended for larger sizes, and the use of a second torch to retain a uniform preheating of the entire fitting assembly may be necessary in larger diameters. Heating can then proceed as outlined in the steps above.

Apply the brazing filler metal at a point where the tube enters the socket of the fitting. When the proper temperature is reached, the filler metal will flow readily into the space between the tube and fitting socket, drawn in by the natural force of capillary action.

Keep the flame away from the filler metal itself as it is fed into the joint. The temperature of the tube and fitting at the joint should be high enough to melt the filler metal.

Keep both the fitting and tube heated by moving the flame back and forth from one to the other as the filler metal is drawn into the joint.

When the joint is properly made, filler metal will be drawn into the fitting socket by capillary action, and a continuous fillet of filler metal will be visible completely around the joint. To aid in the development of this fillet during brazing, the flame should be kept slightly ahead of the point of filler metal application.

Horizontal and Vertical Joints

When brazing horizontal joints, it is preferable to first apply the filler metal slightly off-center at the bottom of the joint, proceeding across the bottom of the joint and continuing up the side to the top of the joint. Then, return to the beginning point, overlapping slightly, and proceed up the uncompleted side to the top, again, overlapping slightly. This procedure is identical to that used for soldering.

Also, similar to the soldering process, make sure the operations overlap. On vertical joints it is immaterial where the start is made. If the opening of the socket is pointing down, care should be taken to avoid overheating the tube, as this may cause the brazing filler metal to run down the outside of the tube.



Removing Residue

After the brazed joint has cooled the flux residue should be removed with a clean cloth, brush or swab using warm water. Remove all flux residue to avoid the risk of the hardened flux temporarily retaining pressure and masking an imperfectly brazed joint. Wrought fittings may be cooled more readily than cast fittings, but all fittings should be allowed to cool naturally before wetting.

General Hints and Suggestions

If the filler metal fails to flow or has a tendency to ball up, it indicates oxidation on the metal surfaces or insufficient heat on the parts to be joined.

If tube or fitting start to oxidize during heating there is too little flux.

If the filler metal does not enter the joint and tends to flow over the outside of either member of the joint, it indicates that one member is overheated or the other is underheated.

Brazing Copper Tube



Brazing Copper Tube

To view the online video, please click the image above, scan the QR code, or follow the link: <https://www.youtube.com/watch?v=07ODV2Bdqow>.

Testing

Test all completed assemblies for joint integrity. Follow the testing procedure prescribed by applicable codes governing the intended service.

Purging

Some installations, such as medical gas, high-purity gas and ACR systems, require the use of an inert gas during the brazing process. The purge gas displaces oxygen from the interior of the system while it is being subjected to the high temperatures of brazing and therefore eliminates the possibility of oxide formation on the interior tube surface.

Purge gas flow rates and methods of application should be included in the Brazing Procedure Specifications of these applications.

How to Braze Threaded Copper Adapters



How to Braze Threaded Copper Adapters

To view the online video, please click the image above, scan the QR code, or follow the link: <https://www.youtube.com/watch?v=fkBCYbfm7vQ>.



9. FLARED JOINTS

While copper tube is usually joined by soldering or brazing, there are times when a mechanical joint may be required or preferred. Flared fittings (**Figures 9.1** and **9.2**) are an alternative when the use of an open flame is either not desired or impractical. Water service applications generally use a flare to iron pipe connection when connecting the copper tube to the main and/or the meter. In addition, copper tube used for Fuel Gas (Liquefied Petroleum (LP), Propane Gas or Natural Gas may be joined utilizing flared brass fittings of single 45°-flare type, according to NFPA 54/ANSI. Z223.1 National Fuel Gas Code. All National Model Codes permit the use of flare joints, but it is important to check with the authority having jurisdiction (AHJ) to determine acceptance for a specific application in any particular jurisdiction.



Figure 9.2. Completed Flared Joint

A flare joint should be made with an appropriate tool such as those supplied by a number of tubing/piping tool manufacturers. Make sure to use a tool that matches the outside diameter of the tube being flared and that has the appropriate flare angle, commonly 45° (the physical characteristics of which should be in accordance with the Society of Automotive Engineers SAE J533 Standard - Flares for Tubing). The tool usually consists of flaring bars with openings for various tube sizes and a yoke that contains the flaring cone and a clamp to grip the flaring bars.

When flaring Types L or K copper tube, annealed or soft temper tube should be used. It is possible to flare Types K, L or M rigid or hard temper tube, though prior to flaring it is usually necessary to anneal the end of the tube to be flared. The copper tube must be cut square using an appropriate tubing cutter. After cutting, the tube must be reamed to the full inside diameter leaving no inside burr (**Figure 9.3**). Tube that is out of round prior to flaring should be resized back to round.



Figure 9.1. Flare Fitting/Flared Joint During Assembly



Figure 9.3. Reaming Prior to Flaring the Tube End



Figure 9.4. Lowering the Flaring Cone Into the Tube End

Failure to complete either of these steps can, lead to an inadequate seal of the flared joint and, ultimately, to joint failure. Dirt, debris and foreign substances should be removed from the tube end to be flared by mechanical cleaning. This can be accomplished with the use of an abrasive cloth (screen cloth, sand cloth, emery cloth or nylon abrasive cloth).

Now, place a flare nut over the end of the tube with the threads closest to the end being flared. Insert the tube between the flaring bars of the flaring tool in the appropriate opening for the diameter of the tube being flared. Adjust the height of the tube in the opening in accordance with the tool manufacturer's instructions, to achieve sufficient length of the flare. Position the yoke with the flaring cone over the tube end and clamp the yoke in place. Turn the handle of the yoke clockwise (**Figure 9.4**). This lowers the flaring cone and forces the lip of the tube against the base of the flaring bar to create an angled flare that will mate securely with a corresponding flare-type fitting. Care should be taken not to over-tighten the cone and cause cracking or deformation of the tube and/or the tool. Some tools also provide a setting for ironing or burnishing the flare, as a final step to achieve a more consistent flare. The final flared tube end should have a smooth, even, round flare of sufficient length to fully engage the mating surface of the flare nut without protruding into the threads (**Figure 9.5**).

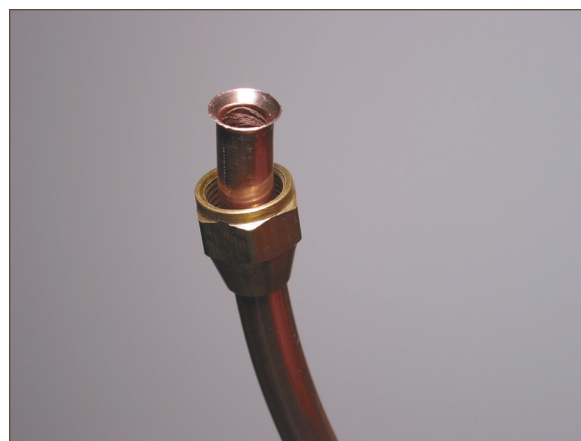

Figure 9.5. Completed Flared Tube End

No material (e.g., pipe joint compound) should be applied to the mating surfaces of the flare fitting and the flared tube end before attaching the flare nut to the fitting body.

How-To: Use Flare Joints for Copper



Flaring

To view the online video, please click the image above, scan the QR code, or follow the link: <https://www.youtube.com/watch?v=llaqTszbh9M>.

10. ROLL GROOVE JOINTS

Grooved-end piping has been familiar to pipe fitters and sprinkler system contractors for many years. Since 1925, this method of joining pipe has been used reliably on steel and iron pipe in HVAC, fire protection, process piping and related applications.

This method of mechanical joining is also available in a system for copper tube in sizes from 2 through 8 inches. Included are couplings, gaskets and a myriad of fitting configurations. The system offers a practical alternative to soldering and brazing larger-diameter copper tube. And most importantly it requires no heat or open flame, as do soldering or brazing.

Copper roll groove joining takes advantage of copper's excellent malleability and its increased strength when cold worked. The joints rely on the sealing capability of a special clamping system that contains an EPDM gasket and a specially designed clamp. Several manufacturers offer roll groove tools, gaskets, clamps and fittings.

Preliminary Requirements

As with all copper no-flame joining processes, proper preparation of the tube end is vitally important to a sound, leak-free joint.

Proper selection of the correct roll grooving tool and heads for each type of tube to be prepared is essential. Manufacturer's recommendations must be followed in order to ensure safe, trouble-free, tube preparation.

Installation Steps

Examine the tube to ensure there are no dents, deep scratches, dirt, oils, grease or other surface imperfections.



Figure 10.1. Inspect tube for imperfections

Measure the tube length accurately.



Figure 10.2. Measure accurately

Cut the tube end square, i.e., perpendicular to the run of the tube.



Figure 10.3. Square-cut tube end

Remove burrs from the I.D. and the O.D. of the tube end by reaming the I.D. and chamfering the O.D. using the appropriate tools.

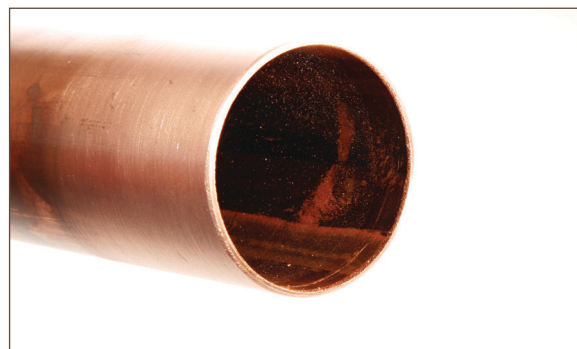

Figure 10.4. Clean and smooth tube end

Roll groove the tubing to the proper dimensions, as required by the fitting manufacturer.

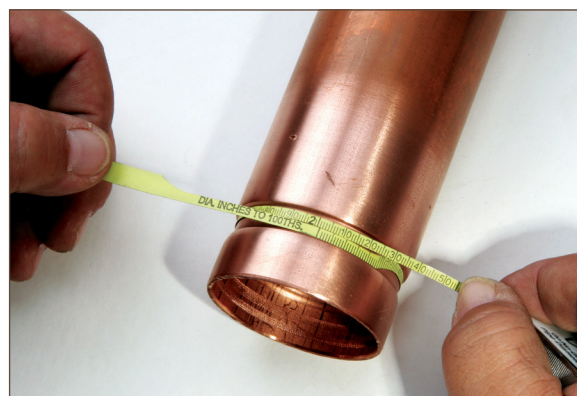

Figure 10.5. Grooved tube end

Examine the fittings, gaskets and clamps to ensure the proper gasket is inserted into the clamp and the fitting end is not damaged.

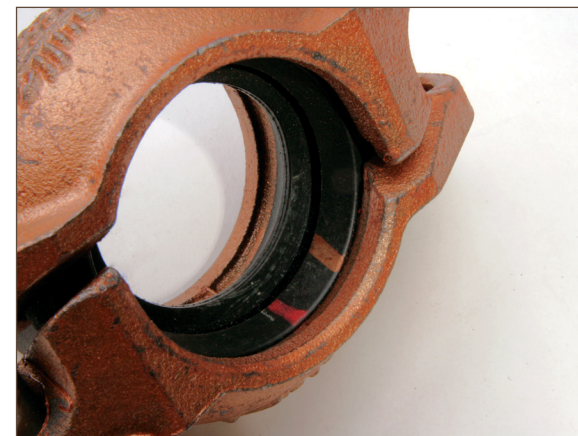

Figure 10.6. Clamp and gasket assembly



Figure 10.7. Selection of fitting, gaskets and clamps

Lubricate the gasket per manufacturer's recommendations.

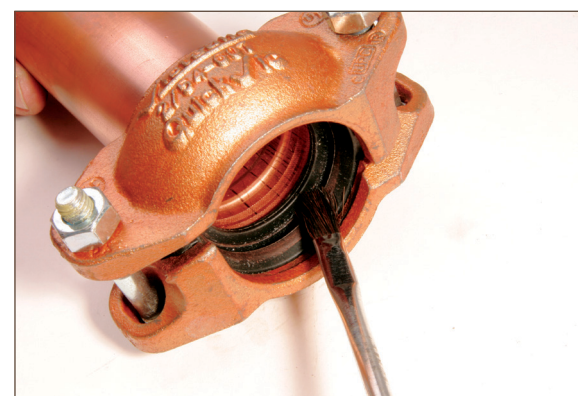

Figure 10.8. Applying lubrication to gasket

Inspect the clamping surfaces to ensure they are clean and free from construction debris. Assemble the joint according to the manufacturer's recommendations.



Figure 10.9. Inspect the surface



Figure 10.10. Assembled joint

Tighten the clamping nuts to the proper torque per manufacturer's recommendations.

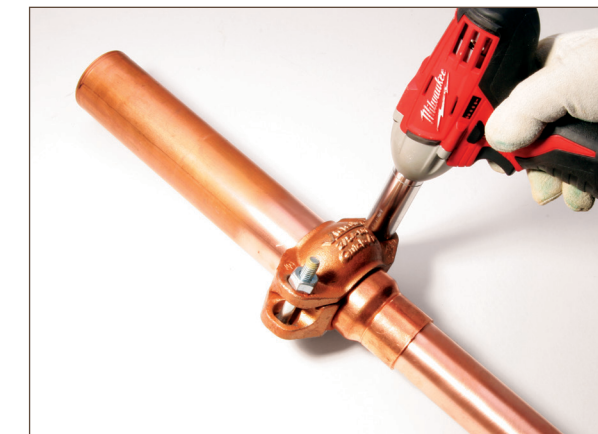

Figure 10.11. Tightening the clamp

Inspect the tightened clamp to ensure it is properly assembled.

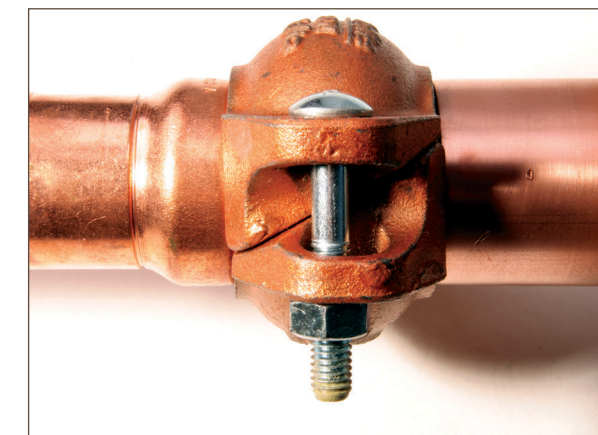

Figure 10.12. Final inspection of completed joint

Testing

Testing of the completed piping system can be accomplished by using pressurized air, water, or hydro-pneumatic testing when the test pressure is relatively high. (Note: test pressures should never exceed the maximum operating pressure specified by the manufacturer of the fitting system.)

11. PRESS-CONNECT JOINTS

Press-connect joining of copper and copper alloy tube is fast, economical, and, most importantly, it requires no heat or open flame unlike soldering or brazing.

The press-connect joining method (sometimes called press-fit) was patented in Europe in the late 1950s and continues to be used successfully there. The method and associated fittings and tools were introduced in the United States in the late 1990s. Since then, there has been growing acceptance, and those using the method experience excellent results.

Press-connect joining takes advantage of copper's excellent malleability and its proven increased strength when cold worked. The joints rely on the sealing capability of a special fitting that contains an elastomeric gasket or seal (such as EPDM) (Figure 11.1) and the proper use of an approved pressing tool and jaws (Figure 11.2). Typical ranges of pressure-temperature ratings for these no-flame joints are found in Table 14.4b. Several manufacturers offer full product lines of press-connect fittings, valves and specialty items (Figure 11.3).

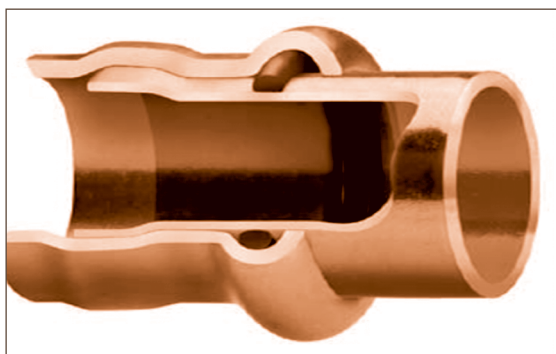

Figure 11.1. Press-connect fitting with elastomeric gasket



Figure 11.2. Press tools and jaws



Figure 11.3. Sample fittings and valves available

Preliminary Requirements

The tube must be examined to ensure that it reveals no dents, deep scratches, dirt, oils, grease or other surface imperfections (Figure 11.4). If tube is found to be slightly oval or out of round, rerounding with an appropriate resizing tool may be required.



Figure 11.4. Inspect tube for imperfections

Installation Steps

Measure tubing accurately to insure it sockets completely to the base of the fitting cup.

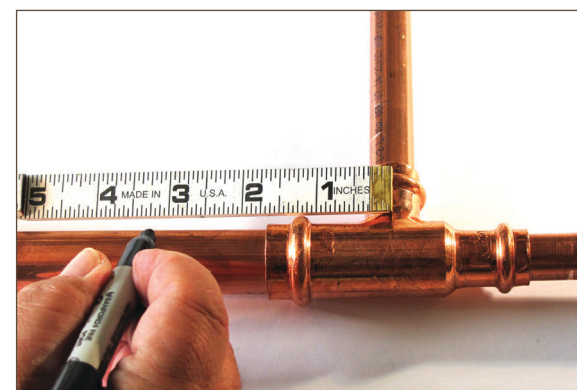

Figure 11.5. Measuring

Cut the tubing square, perpendicular to the run of tube, using an appropriate tube cutter.



Figure 11.6. Cutting the tube square



Figure 11.7. Tube cutters

Burrs must be removed from the I.D. and O.D. of the cut tube end.



Figure 11.8. Reaming tools

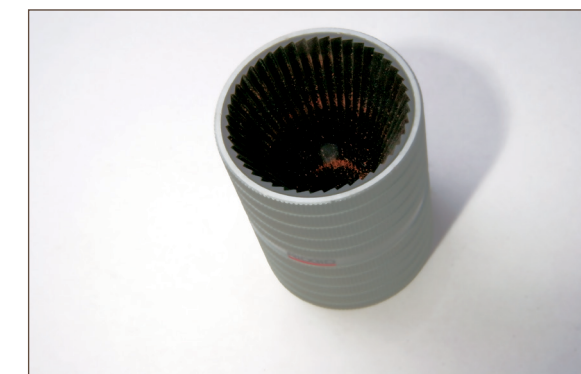

Figure 11.9. Combination tool for I.D and burr removal

Chamfer the cut tube end to reduce the possibility of gasket damage when inserting the tube into the fitting.

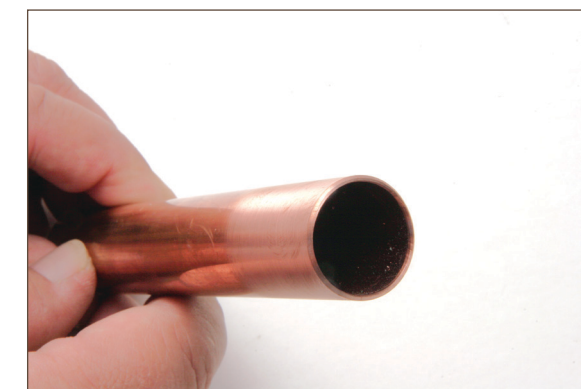

Figure 11.10. Properly prepare tube end

Examine the fitting to be used to ensure the sealing gasket is properly positioned and is not damaged.

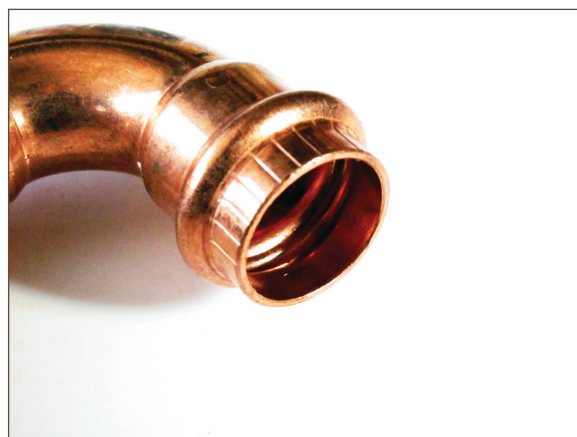

Figure 11.11. Press fitting (NOTE: Missing o-ring)

Depth of insertion must be marked on the tube prior to inserting the tube into the fitting.



Figure 11.12. Measuring depth of insertion

Select the proper size of the appropriate pressing jaw and insert it into the pressing tool.



Figure 11.13. Pressing jaw selections

Ensure the tube is completely inserted to the fitting stop (appropriate depth) and squared with the fitting prior to applying the pressing jaws onto the fitting.



Figure 11.14. Fitting prepared for pressing

Place the pressing jaw over the bead on the fitting and ensure the tool and jaws are at a 90° angle (perpendicular) to the centerline of the tube.

Depress the pressing tool trigger to begin the pressing cycle.

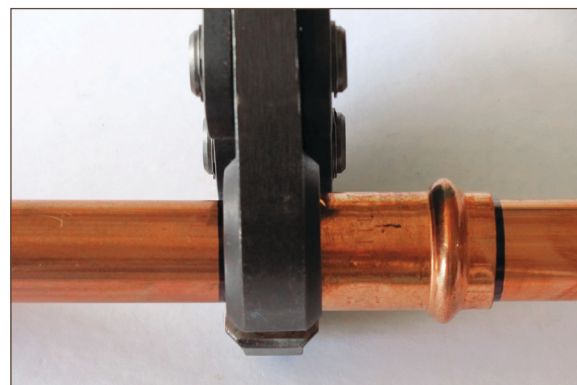

Figure 11.15. Properly positioned press tool

When the pressing cycle is complete, release the pressing jaw and visually inspect the joint to ensure the tube has remained fully inserted, as evidenced by the visible insertion mark.

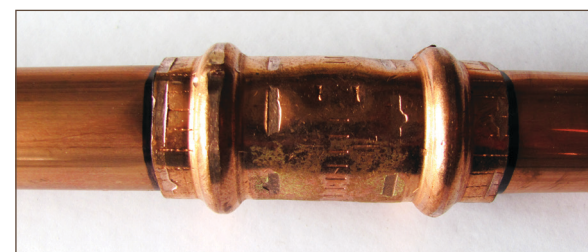

Figure 11.16. Completed installation of a press-connect joint

Press-Connect Joints for HVACR Applications

Advances in press-connect and O-ring/gasket material technology are now such that press-connect joining is being utilized for high pressure HVACR applications rated up to 700 psi operating pressure (see **Table 14.4b**).

To achieve high pressure performance, press-connect fittings for HVACR service utilize one, or a combination of several design changes which may include changes in: 1) the o-ring/gasket design or material composition; 2) the wall-thickness of the fitting body; and/or 3) the geometry of the mechanical crimp/press configuration. In many cases, the geometry of the crimp configuration is similar to that for standard, low-pressure press-connect fittings. Though these may require specially designed jaws to accommodate slight changes in geometry or fitting thickness, the installation steps are essentially the same as those shown in the previous section. Care should be taken to ensure that compatible fittings, tools and jaws are utilized and that the fitting manufacturers' installation instructions are followed.

In other cases, the change in geometry of the higher-pressure HVACR press-connect joint and fitting are quite different than the standard low-pressure press-connect joints, for example to provide a double, 360-degree crimp to one side of the O-ring/gasket. These fittings require the use of specially designed press fittings and crimping jaws to achieve the design pressures of the specific press-connect system (**Figure 11.17**). These fittings and

crimping jaws are not interchangeable with standard low-pressure press-connect systems, so care should be taken to ensure that only the proper, compatible fittings, press jaws and tools are used. Always refer to the manufacturers' installation instructions. Sample installation instructions are shown here as an example.



Figure 11.17. Completed joint showing double 360° crimps

Preparation of the tube ends and deburring of the I.D. and O.D. remain the same as that described in the previous installation steps. However, there are a few critical steps that need to be taken to ensure compliance with the fitting manufacturers' minimum installation requirements.

Full depth of insertion into the fitting shall be clearly marked prior to inserting the tube into the fitting (**Figure 11.18**).



Figure 11.18. Tube marked for insertion into HVACR fitting

Crimping jaw choice and jaw placement prior to crimping are the same as described previously.

Once the pressing process has been completed the jaws can be removed from the fitting and visual examination of the final pressed fitting shall be performed. It is imperative that the tube has remained fully inserted after the pressing process (**Figure 11.19**).



Figure 11.19. Completed joint with insertion marks visible

As a quality control check and visual indicator of crimp completion, some manufacturers include or require that the crimping jaws impart a logo or other crimp mark to the fitting as in integral part of the crimping process. In these cases, the completed double 360° crimp shall be inspected for the appropriate crimp mark as prescribed by the fitting manufacturer (**Figure 11.20**).



Figure 11.20. Press jaw crimp mark

Fitting manufacturers may also require additional verification steps to ensure proper crimp completion, such as verification of the final crimp dimensions with some type of go-no-go gage, (**Figure 11.21, 11.22**).



Figure 11.21. Un-crimped or improperly crimped fitting



Figure 11.22. Correctly crimped fitting

Testing

Testing of the completed piping system can be accomplished by using pressurized air, water, or hydro-pneumatic testing when the test pressure is relatively high. (Note: *test pressures should never exceed the maximum operating pressure specified by the manufacturer of the fitting system.*)

12. PUSH-CONNECT JOINTS

Like the press-connect joining method, the push-connect joining of copper and copper alloy tube is fast, economical and, also, requires no heat or open flame. However, unlike most other joining methods, no additional tools, special fuel gases or electrical power are required for installation.

Push-connect joining utilizes an integral elastomeric gasket or seal (such as EPDM) and stainless steel grab ring to produce a strong, leak-free joint. Typical ranges of pressure-temperature ratings for these no-flame joints are found in **Table 14.4b**.

There are two common types of push-connect fittings. Both create strong, permanent joints however one allows for easy removal after installation (**Figure 12.1**) to allow for equipment service, while the second type (**Figure 12.2**) cannot be easily removed once the fitting is installed.



Figure 12.1. Removable push-connect fitting



Figure 12.2. Permanent push-connect fitting

Preliminary Requirements

The tube must be examined to ensure that it reveals no dents, deep scratches, dirt, oils, paint, grease or other surface imperfections (**Figure 12.3**).



Figure 12.3. Ensure tube is clean, round and free of imperfections

Installation Steps

Measure the tube accurately to ensure it will socket to the back of the fitting cup (Figure 12.4).



Figure 12.4. Measuring

Cut the tube square, perpendicular to the run of tube, using an appropriate tubing cutter (Figure 12.5).



Figure 12.5. Tube cutters

Remove burrs from the I.D. and O.D. of the cut tube end by reaming the I.D. and chamfering the O.D. using the appropriate tools (Figure 12.6 and 12.7).

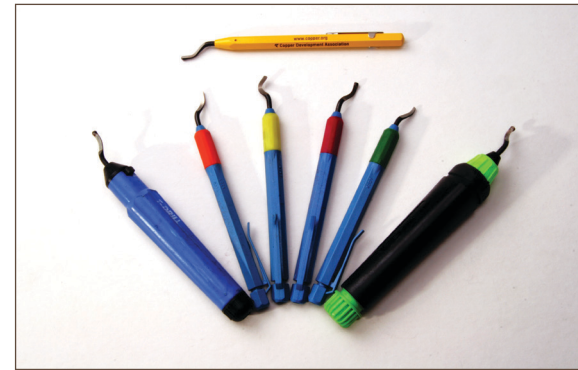

Figure 12.6. Reaming tools

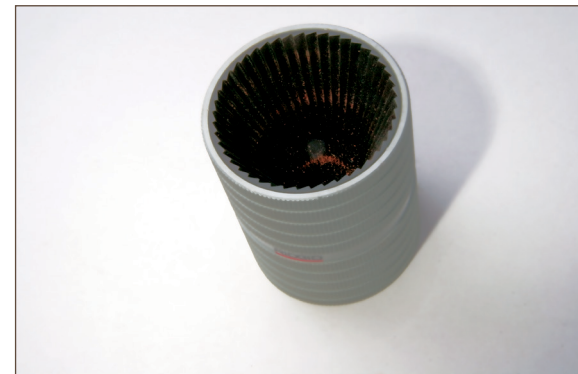

Figure 12.7. Chamfer tool

Chamfering the cut tube end is required to reduce the possibility of gasket damage when inserting the tube. Cleaning of the chamfered tube end with emery paper, nylon abrasive cloth or plumber's cloth will ensure that no sharp edges or nicks are present, which might damage the sealing gasket upon insertion of the tube into the fitting (Figure 12.8).

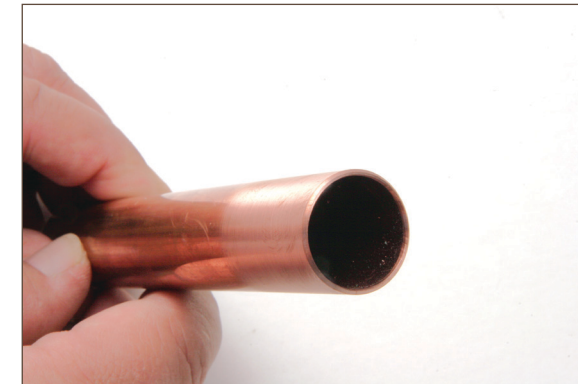

Figure 12.8. Chamfered tube end

Examine the fitting to be used to ensure the sealing gasket and gripper ring are properly positioned and not damaged (Figure 12.9).



Figure 12.9. Fitting

Mark the depth of insertion on the tube prior to inserting it into the fitting (Figure 12.10).



Figure 12.10. Making insertion depth

Lubrication of the tube end may or may not be required. Follow the manufacturer's installation recommendations related to pre-lubrication of the tube end.

Align the tube so that it is straight and in line with the fitting (Figure 12.11).

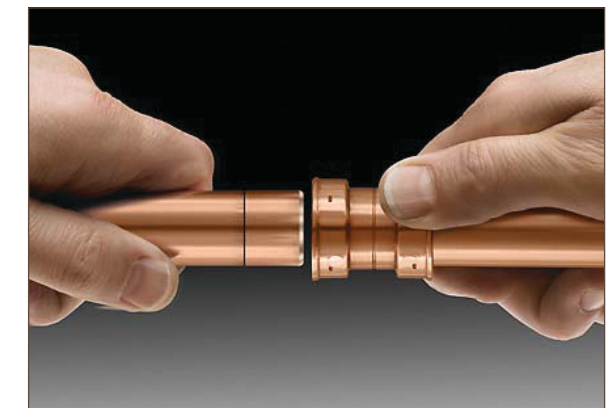

Figure 12.11. Aligning tube end squarely



Using a firm pushing and twisting motion, insert the tube into the fitting and push the tube and fitting together until the tube is seated at the back of the fitting cup as evidenced by the pre-marked tube insertion depth line (**Figure 12.12**).

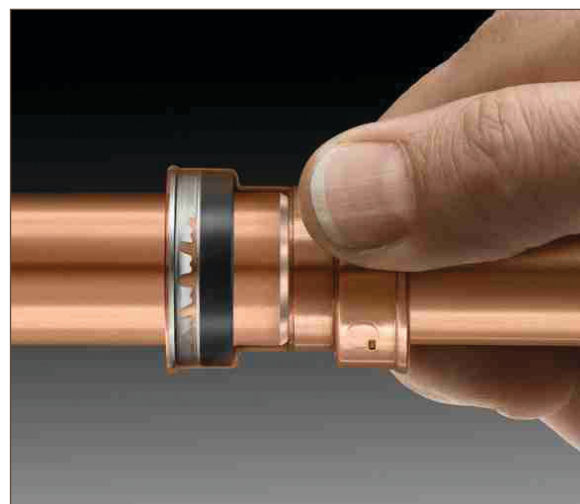

Figure 12.12. Completed installation of a push-connect joint

Testing

Testing of the completed piping system can be accomplished by using pressurized air or water as required by local codes or project specifications. (Note: *test pressures should never exceed the maximum operating pressure specified by the manufacturer of the fitting system.*)

13. MECHANICALLY FORMED EXTRUDED OUTLETS

Another joining technology that has been used effectively for many years involves a hand tool designed to quickly pull tee connections and outlets from the run of the tube, thus reducing the number of tee fittings and soldered or brazed joints. It allows branches to be formed faster and usually results in a lower installed system cost. This method may be used for general plumbing, HVAC, refrigeration, fire sprinkler and service projects (**Figure 13.1**).

A tube end prep tool that forms the end of a branch pipe to match the inner curve of the run tube while simultaneously pressing two dimples in the end of the branch tube. One acts as a depth stop and the other for inspection of the joint after brazing.

Be sure the pipes (run and branch) are drained and not under pressure.



Figure 13.1. Mechanically formed extruded outlet requires only one brazed joint

Portable hand tool kits and power operated equipment are available that produce lap joints for brazing. The system can be used with Types K, L or M copper tube to form 1/2" to 4" outlets from 1/2" to 8" tubes, depending on tool selection. The installation descriptions below are for illustrative purposes only. It is essential that the manufacturer's instructions and guidelines are followed exactly to ensure proper installation and safe performance.



Figure 13.2. Power operated accessory tool kit

Preliminary Requirements

Be sure to have all tool kit components handy (**Figure 13.2**). They typically include:

The tee-forming power drill outlet pulling tools and the manufacturer's instructions for their use and proper application.

Installation Steps

The procedure that follows is typical for the forming and brazing of 1/2" to 1 1/4" outlets using power operated equipment. Although there are specific steps to be followed, the tee-forming and brazing process takes little time and is quickly repeatable. Follow the manufacturer's operating instructions for all tube sizes.

Select and adjust the drill head and forming pins according to the manufacturer's instructions. The drill bit and pins are quite sharp, so caution is in order.

Insert the drill head into the chuck and extend the forming pins.

Lubricate the drill head and forming pins (Figure 13.3).



Figure 13.3: Lubricating the drill head

Press in the conical cover and rotate counterclockwise to retract the forming pins (Figure 13.4).

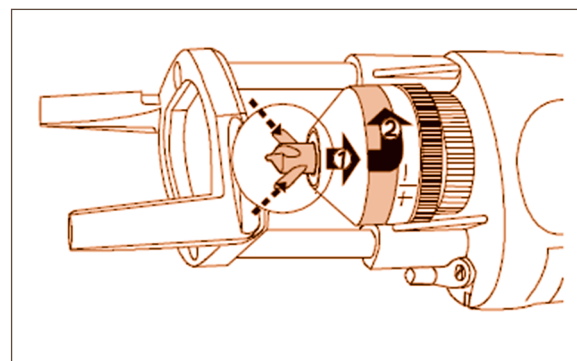

Figure 13.4: Retracting the forming pins

On tube sizes over 2", the area for forming the tee outlet must be annealed first. See manufacturer's instructions when dealing with these sizes.

Pull out the support legs and place the tube support firmly onto the point where the tee is to be formed on the tube. Then, twist the machine counterclockwise at the handle of the tool to center the drill head on the tube (Figure 13.5). The legs will center and support the drill while absorbing all rotational torque.

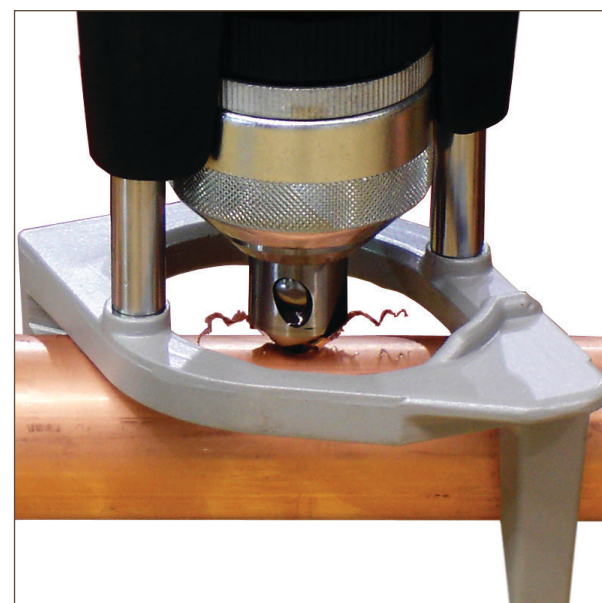

Figure 13.5. Positioning the drill tip and ensure a snug fit of the support legs

Start the tool by squeezing the trigger and drill until the bit has fully penetrated into the tube. Then, release the trigger to stop the drill.

Extend the forming pins on the drill head by pressing the cover toward the tool and rotating it counterclockwise until the head locks in the tee-forming position (Figure 13.6). Do not extend the forming pins while the motor is running.

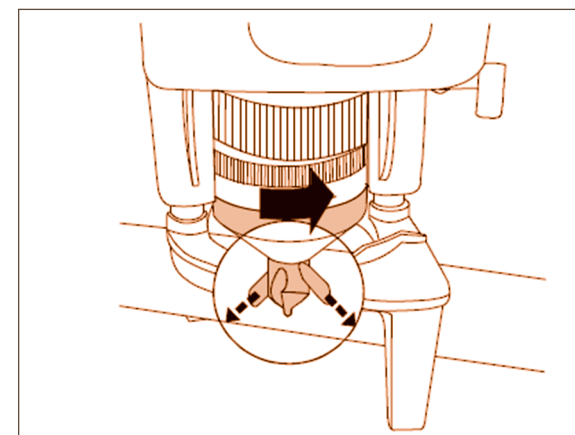

Figure 13.6: Extending the forming pins inside the run tube

Turn the speed selector control to the slowest position (typical). Engage the feed mechanism. You may have to rotate the motor by giving a nudge on the trigger.

Squeeze the trigger to start forming the outlet and continue until the drill head is completely out of the tube. Maintain a slight downward pressure on the drill to ensure a firm contact with the tube (Figure 13.7). The rotation of the forming pins causes a back flow and thickening of the metal around the lower circumference of the outlet.

It is important to release the drill trigger as soon as the drill head clears the rim of the outlet. NOTE: Removing the drill head from the tube before it emerges will result in an oval or imperfect outlet.

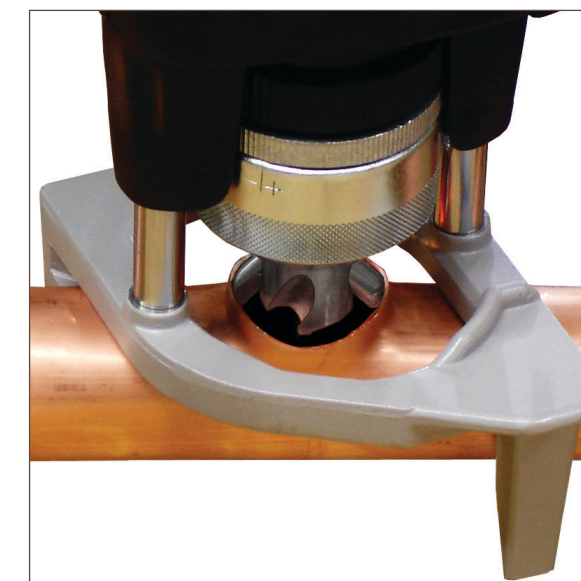

Figure 13.7. Forming the outlet

Ream and deburr the branch tube end (Figure 13.8).



Figure 13.8. Reamed and deburred branch tube end



Choose the appropriate branch-size dye on the tube-end notcher to notch and dimple the sides of the branch tube end. Proper notching and dimpling must be performed to meet code requirements and to ensure the branch does not protrude into the tube (Figure 13.9 and 13.10).

Insert the branch tube into the outlet up to the first dimple and align the dimples with the run of the tube (Figure 13.11).



Figure 13.9. Using the notching and dimpling tool



Figure 13.11. Aligning the dimples with the run of the tube

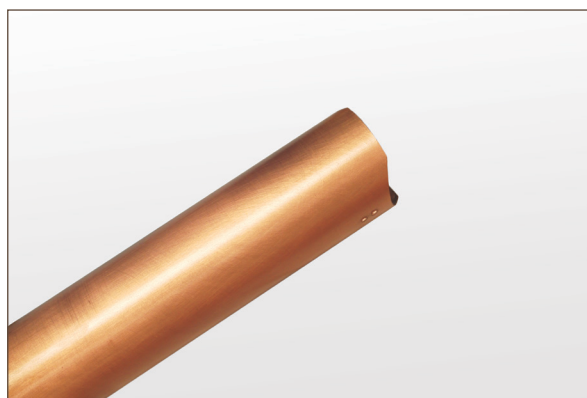

Figure 13.10. Properly prepared branch end tube

Braze the joint (Figure 13.12).

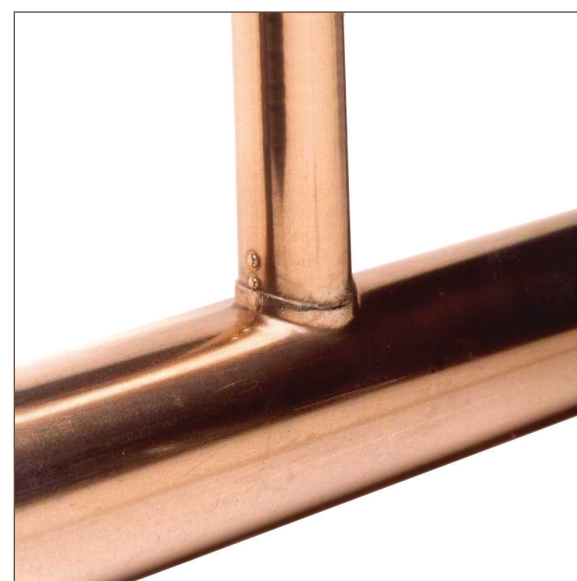

Figure 13.12. Finished joint

Remove any excess lubricant from inside the outlet and use Scotchbrite™ or sand cloth to clean the inside of the outlet rim.

Testing

All drilling residue and debris must be flushed out before using the system.

Final pressure testing of the completed piping system is accomplished by using pressurized air or water as required by local codes or project specifications. (Note: test pressures should never exceed the maximum operating pressure specified by the manufacturer of the fitting system.)

Solderless Fittings



Solderless Fittings

To view the online video, please click the image above, scan the QR code, or follow the link: https://www.youtube.com/watch?v=l47ncSIM_tU.



TECHNICAL DATA



14. TABLES AND FIGURES

TABLE 14.1. Copper Tube: Types, Standards, Applications, Tempers, Lengths

Tube type	Color code	Standard	Application ¹	Commercially available lengths ²		
				Nominal or standard sizes	Drawn	Annealed
Type K	Green	ASTM B 88 ³	- Domestic water service and distribution - Fire protection - Solar - Fuel/fuel oil - HVAC - Snow melting - Compressed air - Natural gas - Liquefied petroleum (LP) gas - Vacuum	Straight lengths:		
				¼ inch to 8 inch	20 ft.	20 ft.
				10 inch	18 ft.	18 ft.
				12 inch	12 ft.	12 ft.
				Coils:		
				¼ inch to 1 inch	-	60 ft.
				-	-	100 ft.
Type L	Blue	ASTM B 88	- Domestic water service and distribution - Fire protection - Solar - Fuel/fuel oil - Natural gas - Liquefied petroleum (LP) gas - HVAC - Snow melting - Compressed air - Vacuum	Straight lengths:		
				¼ inch to 10 inch	20 ft.	20 ft.
				12 inch	18 ft.	18 ft.
				Coils:		
				¼ to 1 inch	-	60 ft.
				-	-	100 ft.
				1½ inch to 1½ inch	-	60 ft.
Type M	Red	ASTM B 88	- Domestic water service and distribution - Fire protection - Solar - Fuel/fuel oil - HVAC - Snow melting - Vacuum	Straight lengths:		
				¼ inch to 12 inch	20 ft.	N/A
				Coils:		
				2 inch	-	45 ft.
DWV	Yellow	ASTM B 306	- Drain, waste, vent - HVAC - Solar	Straight lengths:		
				1¼ inch to 8 inch	20 ft.	N/A
ACR	Blue	ASTM B 280	- Air conditioning - Refrigeration - Natural gas - Liquefied petroleum (LP) gas - Compressed air	Straight lengths:		
				¼ inch to 4½ inch	20 ft.	⁴
				Coils:		
OXY, MED OXY/ MED OXY/ACR ACR/MED	(K) Green (L) Blue	ASTM B 819	- Medical gas - Compressed medical air - Vacuum	Straight lengths:		
				¼ inch to 8 inch	20 ft.	N/A

1. There are many other copper and copper alloy tubes and pipes available for specialized applications. For information on these products, contact the Copper Development Association Inc.
2. Individual manufacturers may have commercially available lengths in addition to those shown in this table.
3. Tube made to other ASTM standards is also intended for plumbing applications, although ASTM B88 is by far the most widely used. ASTM Standard Classification B 698 lists six plumbing tube standards including B 88.
4. Available as special order only.

14. TECHNICAL DATA



TABLE 14.2a. Dimensions and Physical Characteristics of Copper Tube: Type K

Nominal or standard size, inches	Nominal dimensions, inches			Calculated values (based on nominal dimensions)				
	Outside diameter	Inside diameter	Wall thickness	Cross sectional area of bore, sq. inches	Weight of tube only, pounds per linear ft.	Weight of tube & water, pounds per linear ft.	Volume of tube, per linear ft.	
							Cu ft.	Gal.
¼	.375	.305	.035	.073	.145	.177	.00051	.00379
⅜	.500	.402	.049	.127	.269	.324	.00088	.00660
½	.625	.527	.049	.218	.344	.438	.00151	.0113
⅝	.750	.652	.049	.334	.418	.562	.00232	.0174
¾	.875	.745	.065	.436	.641	.829	.00303	.0227
1	1.125	.995	.065	.778	.839	1.18	.00540	.0404
1¼	1.375	1.245	.065	1.22	1.04	1.57	.00847	.0634
1½	1.625	1.481	.072	1.72	1.36	2.10	.0119	.0894
2	2.125	1.959	.083	3.01	2.06	3.36	.0209	.156
2½	2.625	2.435	.095	4.66	2.93	4.94	.0324	.242
3	3.125	2.907	.109	6.64	4.00	6.87	.0461	.345
3½	3.625	3.385	.120	9.00	5.12	9.01	.0625	.468
4	4.125	3.857	.134	11.7	6.51	11.6	.0813	.608
5	5.125	4.805	.160	18.1	9.67	17.5	.126	.940
6	6.125	5.741	.192	25.9	13.9	25.1	.180	1.35
8	8.125	7.583	.271	45.2	25.9	45.4	.314	2.35
10	10.125	9.449	.338	70.1	40.3	70.6	.487	3.64
12	12.125	11.315	.405	101	57.8	101	.701	5.25

TABLE 14.2b. Dimensions and Physical Characteristics of Copper Tube: Type L

Nominal or standard size, inches	Nominal dimensions, inches			Calculated values (based on nominal dimensions)				
	Outside diameter	Inside diameter	Wall thickness	Cross sectional area of bore, sq. inches	Weight of tube only, pounds per linear ft.	Weight of tube & water, pounds per linear ft.	Volume of tube, per linear ft.	
							Cu ft.	Gal.
¼	.375	.315	.030	.078	.126	.160	.00054	.00405
⅜	.500	.430	.035	.145	.198	.261	.00101	.00753
½	.625	.545	.040	.233	.285	.386	.00162	.0121
⅝	.750	.666	.042	.348	.362	.506	.00232	.0174
¾	.875	.785	.045	.484	.455	.664	.00336	.0251
1	1.125	1.025	.050	.825	.655	1.01	.00573	.0429
1¼	1.375	1.265	.055	1.26	.884	1.43	.00875	.0655
1½	1.625	1.505	.060	1.78	1.14	1.91	.0124	.0925
2	2.125	1.985	.070	3.09	1.75	3.09	.0215	.161
2½	2.625	2.465	.080	4.77	2.48	4.54	.0331	.248
3	3.125	2.945	.090	6.81	3.33	6.27	.0473	.354
3½	3.625	3.425	.100	9.21	4.29	8.27	.0640	.478
4	4.125	3.905	.110	12.0	5.38	10.1	.0764	.571
5	5.125	4.875	.125	18.7	7.61	15.7	.130	.971
6	6.125	5.845	.140	26.8	10.2	21.8	.186	1.39
8	8.125	7.725	.200	46.9	19.3	39.6	.326	2.44
10	10.125	9.625	.250	72.8	30.1	61.6	.506	3.78
12	12.125	11.565	.280	105	40.4	85.8	.729	5.45

TABLE 14.2c. Dimensions and Physical Characteristics of Copper Tube: Type M

Nominal or standard size, inches	Nominal dimensions, inches			Calculated values (based on nominal dimensions)				
	Outside diameter	Inside diameter	Wall thickness	Cross sectional area of bore, sq. inches	Weight of tube only, pounds per linear ft.	Weight of tube & water, pounds per linear ft.	Volume of tube, per linear ft.	
							Cu ft.	Gal.
3/8	.500	.450	.025	.159	.145	.214	.00110	.00826
1/2	.625	.569	.028	.254	.204	.314	.00176	.0132
3/4	.875	.811	.032	.517	.328	.551	.00359	.0269
1	1.125	1.055	.035	.874	.465	.843	.00607	.0454
1 1/4	1.375	1.291	.042	1.31	.682	1.25	.00910	.0681
1 1/2	1.625	1.527	.049	1.83	.940	1.73	.0127	.0951
2	2.125	2.009	.058	3.17	1.46	2.83	.0220	.165
2 1/2	2.625	2.495	.065	4.89	2.03	4.14	.0340	.254
3	3.125	2.981	.072	6.98	2.68	5.70	.0485	.363
3 1/2	3.625	3.459	.083	9.40	3.58	7.64	.0653	.488
4	4.125	3.935	.095	12.2	4.66	9.83	.0847	.634
5	5.125	4.907	.109	18.9	6.66	14.8	.131	.982
6	6.125	5.881	.122	27.2	8.92	20.7	.189	1.41
8	8.125	7.785	.170	47.6	16.5	37.1	.331	2.47
10	10.125	9.701	.212	73.9	25.6	57.5	.513	3.84
12	12.125	11.617	.254	106	36.7	82.5	.736	5.51

14. TECHNICAL DATA

TABLE 14.2d. Dimensions and Physical Characteristics of Copper Tube: DWV (Drain, Waste and Vent)

Nominal or standard size, inches	Nominal dimensions, inches			Calculated values (based on nominal dimensions)				
	Outside diameter	Inside diameter	Wall thickness	Cross sectional area of bore, sq. inches	Weight of tube only, pounds per linear ft.	Weight of tube & water, pounds per linear ft.	Volume of tube, per linear ft.	
							Cu ft.	Gal.
1 1/4	1.375	1.295	.040	1.32	.650	1.22	.00917	.0686
1 1/2	1.625	1.541	.042	1.87	.809	1.62	.0130	.0971
2	2.125	2.041	.042	3.27	1.07	2.48	.0227	.170
3	3.125	3.030	.045	7.21	1.69	4.81	.0501	.375
4	4.125	4.009	.058	11.6	2.87	7.88	.0806	.603
5	5.125	4.981	.072	19.5	4.43	12.9	.135	1.01
6	6.125	5.959	.083	27.9	6.10	18.2	.194	1.45
8	8.125	7.907	.109	49.1	10.6	31.8	.341	2.55

14. TECHNICAL DATA

TABLE 14.2e. Dimensions and Physical Characteristics of Copper Tube: ACR (Air-Conditioning and Refrigeration Field Service)

Nominal or Standard Size, inches		Nominal dimensions, inches			Calculated values (based on nominal dimensions)				
		Outside diameter	Inside diameter	Wall thickness	Cross sectional area of bore, sq. inches	External surface, sq. ft. per linear ft.	Internal surface, sq. ft. per linear ft.	Weight of tube only, pounds per linear ft.	Volume of tube, cu. ft. per linear ft.
1/8	A	.125	.065	.030	.00332	.0327	.0170	.0347	.00002
	D	.125	.065	.030	.00332	.0327	.0170	.0347	.00002
3/16	A	.187	.128	.030	.0129	.0492	.0335	.0575	.00009
	D	.187	.128	.030	.0129	.0492	.0335	.0575	.00009
1/4	A	.250	.190	.030	.0284	.0655	.0497	.0804	.00020
	D	.250	.200	.025	.0314	.0655	.0524	.0680	.00022
5/16	A	.312	.248	.032	.0483	.0817	.0649	.109	.00034
	D	.312	.248	.032	.0483	.0817	.0649	.109	.00034
3/8	A	.375	.311	.032	.076	.0982	.0814	.134	.00053
	D	.375	.315	.030	.078	.0982	.0821	.126	.00054
1/2	A	.500	.436	.032	.149	.131	.114	.182	.00103
	D	.500	.430	.035	.145	.131	.113	.198	.00101
5/8	A	.625	.555	.035	.242	.164	.145	.251	.00168
	D	.625	.545	.040	.233	.164	.143	.285	.00162
3/4	A	.750	.680	.035	.363	.196	.178	.305	.00252
	D	.750	.666	.042	.348	.196	.174	.362	.00242
7/8	A	.875	.785	.045	.484	.229	.206	.455	.00336
	D	.875	.785	.045	.484	.229	.206	.455	.00336
1 1/8	A	1.125	1.025	.050	.825	.294	.268	.655	.00573
	D	1.125	1.025	.050	.825	.294	.268	.655	.00573
1 1/4	A	1.375	1.265	.055	1.26	.360	.331	.884	.00875
	D	1.375	1.265	.055	1.26	.360	.331	.884	.00875
1 1/2	A	1.625	1.505	.060	1.78	.425	.394	1.14	.0124
	D	1.625	1.505	.060	1.78	.425	.394	1.14	.0124
2 1/8	D	2.125	1.985	.070	3.09	.556	.520	1.75	.0215
	D	2.625	2.465	.080	4.77	.687	.645	2.48	.0331
3 1/8	D	3.125	2.945	.090	6.81	.818	.771	3.33	.0473
	D	3.625	3.425	.100	9.21	.949	.897	4.29	.0640
4 1/8	D	4.125	3.905	.110	12.0	1.08	1.02	5.38	.0833

A = Annealed Temper, D = Drawn Temper

TABLE 14.2f. Dimensions and Physical Characteristics of Copper Tube: Medical Gas, K and L

Nominal or standard size, inches		Nominal dimensions, inches			Calculated values (based on nominal dimensions)			
		Outside diameter	Inside diameter	Wall thickness	Cross sectional area of bore, sq. inches	Internal surface, sq. ft. per linear ft.	Weight of tube only, pounds per linear ft.	Volume of tube, cu. ft. per linear ft.
1/4	K	.375	.305	.035	.073	.0789	.145	.00051
	L	.375	.315	.030	.078	.0825	.126	.00054
3/8	K	.500	.402	.049	.127	.105	.269	.00088
	L	.500	.430	.035	.145	.113	.198	.00101
1/2	K	.625	.527	.049	.218	.130	.344	.00151
	L	.625	.545	.040	.233	.143	.285	.00162
5/8	K	.750	.652	.049	.334	.171	.418	.00232
	L	.750	.666	.042	.348	.174	.362	.00242
3/4	K	.875	.745	.065	.436	.195	.641	.00303
	L	.875	.785	.045	.484	.206	.455	.00336
1	K	1.125	.995	.065	.778	.261	.839	.00540
	L	1.125	1.025	.050	.825	.268	.655	.00573
1 1/4	K	1.375	1.245	.065	1.222	.326	1.04	.00845
	L	1.375	1.265	.055	1.26	.331	.884	.00873
1 1/2	K	1.625	1.481	.072	1.72	.388	1.36	.0120
	L	1.625	1.505	.060	1.78	.394	1.14	.0124
2	K	2.125	1.959	.083	3.01	.522	2.06	.0209
	L	2.125	1.985	.070	3.09	.520	1.75	.0215
2 1/2	K	2.625	2.435	.095	4.66	.638	2.93	.0323
	L	2.625	2.465	.080	4.77	.645	2.48	.0331
3	K	3.125	2.907	.109	6.64	.761	4.00	.0461
	L	3.125	2.945	.090	6.81	.761	3.33	.0473
3 1/2	K	3.625	3.385	.120	9.00	.886	5.12	.0625
	L	3.625	3.425	.100	9.21	.897	4.29	.0640
4	K	4.125	3.857	.134	11.7	1.01	6.51	.0811
	L	4.125	3.905	.110	12.0	1.02	5.38	.0832
5	K	5.125	4.805	.160	18.1	1.26	9.67	.126
	L	5.125	4.875	.125	18.7	1.28	7.61	.130
6	K	6.125	5.741	.192	25.9	1.50	13.9	.180
	L	6.125	5.854	.140	26.8	1.53	10.2	.186
8	K	8.125	7.583	.271	45.2	1.99	25.9	.314
	L	8.125	7.725	.200	46.9	2.02	19.3	.325

TABLE 14.3a. Calculated Rated Internal Working Pressures for Copper Tube: Type K*

Nominal or standard size, in inches	Annealed							Drawn**							
	S= 6,000 psi 100F	S= 5,100 psi 150F	S= 4,900 psi 200F	S= 4,800 psi 250F	S= 4,700 psi 300F	S= 4,000 psi 350F	S= 3,000 psi 400F	S= 10,300 psi 100F	S= 10,300 psi 150F	S= 10,300 psi 200F	S= 10,300 psi 250F	S= 10,000 psi 300F	S= 9,700 psi 350F	S= 9,400 psi 400F	
¼	1074	913	877	860	842	716	537	1850	1850	1850	1850	1796	1742	1688	
⅜	1130	960	923	904	885	753	565	1946	1946	1946	1946	1889	1833	1776	
½	891	758	728	713	698	594	446	1534	1534	1534	1534	1490	1445	1400	
⅝	736	626	601	589	577	491	368	1266	1266	1266	1266	1229	1193	1156	
¾	852	724	696	682	668	568	426	1466	1466	1466	1466	1424	1381	1338	
1	655	557	535	524	513	437	327	1126	1126	1126	1126	1093	1061	1028	
1¼	532	452	434	425	416	354	266	914	914	914	914	888	861	834	
1½	494	420	404	396	387	330	247	850	850	850	850	825	801	776	
2	435	370	355	348	341	290	217	747	747	747	747	726	704	682	
2½	398	338	325	319	312	265	199	684	684	684	684	664	644	624	
3	385	328	315	308	302	257	193	662	662	662	662	643	624	604	
3½	366	311	299	293	286	244	183	628	628	628	628	610	592	573	
4	360	306	294	288	282	240	180	618	618	618	618	600	582	564	
5	345	293	281	276	270	230	172	592	592	592	592	575	557	540	
6	346	295	283	277	271	231	173	595	595	595	595	578	560	543	
8	369	314	301	295	289	246	184	634	634	634	634	615	597	578	
10	369	314	301	295	289	246	184	634	634	634	634	615	597	578	
12	370	314	302	296	290	247	185	635	635	635	635	617	598	580	

* Based on maximum allowable stress in tension (psi) for the indicated temperatures (°F), see **Pressure Ratings and Burst Strength**.

** When brazing or welding is used to join drawn tube, the corresponding annealed rating must be used, see **Pressure Ratings and Burst Strength**.

TABLE 14.3b. Calculated Rated Internal Working Pressure for Copper Tube: Type L*

Nominal or standard size, in inches	Annealed							Drawn**							
	S= 6000 psi 100F	S= 5100 psi 150F	S= 4900 psi 200F	S= 4800 psi 250F	S= 4700 psi 300F	S= 4000 psi 350F	S= 3000 psi 400F	S= 10,300 psi 100F	S= 10,300 psi 150F	S= 10,300 psi 200F	S= 10,300 psi 250F	S= 10,000 psi 300F	S= 9,700 psi 350F	S= 9,400 psi 400F	
¼	912	775	745	729	714	608	456	1569	1569	1569	1569	1524	1478	1432	
⅜	779	662	636	623	610	519	389	1341	1341	1341	1341	1302	1263	1224	
½	722	613	589	577	565	481	361	1242	1242	1242	1242	1206	1169	1133	
⅝	631	537	516	505	495	421	316	1086	1086	1086	1086	1055	1023	991	
¾	582	495	475	466	456	388	291	1002	1002	1002	1002	972	943	914	
1	494	420	404	395	387	330	247	850	850	850	850	825	801	776	
1¼	439	373	358	351	344	293	219	755	755	755	755	733	711	689	
1½	408	347	334	327	320	272	204	702	702	702	702	682	661	641	
2	364	309	297	291	285	242	182	625	625	625	625	607	589	570	
2½	336	285	274	269	263	224	168	577	577	577	577	560	544	527	
3	317	270	259	254	248	211	159	545	545	545	545	529	513	497	
3½	304	258	248	243	238	202	152	522	522	522	522	506	491	476	
4	293	249	240	235	230	196	147	504	504	504	504	489	474	460	
5	269	229	220	215	211	179	135	462	462	462	462	449	435	422	
6	251	213	205	201	196	167	125	431	431	431	431	418	406	393	
8	270	230	221	216	212	180	135	464	464	464	464	451	437	424	
10	271	231	222	217	212	181	136	466	466	466	466	452	439	425	
12	253	215	207	203	199	169	127	435	435	435	435	423	410	397	

* Based on maximum allowable stress in tension (psi) for the indicated temperatures (°F), see **Pressure Ratings and Burst Strength**.

** When brazing or welding is used to join drawn tube, the corresponding annealed rating must be used, see **Pressure Ratings and Burst Strength**.

TABLE 14.3c. Calculated Rated Internal Working Pressure for Copper Tube: Type M*

Nominal or standard size, in inches	Annealed***							Drawn**						
	S=6000 psi 100F	S=5100 psi 150F	S=4900 psi 200F	S=4800 psi 250F	S=4700 psi 300F	S=4000 psi 350F	S=3000 psi 400F	S=10,300 psi 100F	S=10,300 psi 150F	S=10,300 psi 200F	S=10,300 psi 250F	S=10,000 psi 300F	S=9,700 psi 350F	S=9,400 psi 400F
	1/4	-	-	-	-	-	-	-	-	-	-	-	-	-
3/8	570	485	466	456	447	380	285	982	982	982	982	953	925	896
1/2	494	420	403	395	387	329	247	850	850	850	850	825	800	776
5/8	-	-	-	-	-	-	-	-	-	-	-	-	-	-
3/4	407	346	332	326	319	271	204	701	701	701	701	680	660	639
1	337	286	275	270	264	225	169	580	580	580	580	563	546	529
1 1/4	338	287	276	271	265	225	169	582	582	582	582	565	548	531
1 1/2	331	282	270	265	259	221	166	569	569	569	569	553	536	520
2	299	254	244	239	234	199	149	514	514	514	514	499	484	469
2 1/2	274	233	224	219	215	183	137	471	471	471	471	457	444	430
3	253	215	207	203	199	169	127	435	435	435	435	423	410	397
3 1/2	252	214	206	202	197	168	126	433	433	433	433	421	408	395
4	251	213	205	201	197	167	126	431	431	431	431	419	406	394
5	233	198	190	186	182	155	116	400	400	400	400	388	377	365
6	218	186	178	175	171	146	109	375	375	375	375	364	353	342
8	229	195	187	183	180	153	115	394	394	394	394	382	371	359
10	230	195	188	184	180	153	115	394	394	394	394	383	371	360
12	230	195	188	184	180	153	115	395	395	395	395	383	372	360

TABLE 14.3d. Calculated Rated Internal Working Pressure for Copper Tube: DWV*

Nominal or standard size, in inches	Annealed***							Drawn**						
	S=6000 psi 100F	S=5100 psi 150F	S=4900 psi 200F	S=4800 psi 250F	S=4700 psi 300F	S=4000 psi 350F	S=3000 psi 400F	S=10,300 psi 100F	S=10,300 psi 150F	S=10,300 psi 200F	S=10,300 psi 250F	S=10,000 psi 300F	S=9,700 psi 350F	S=9,400 psi 400F
	1/4	330	280	269	264	258	220	165	566	566	566	566	549	533
1 1/2	293	249	240	235	230	196	147	503	503	503	503	489	474	459
2	217	185	178	174	170	145	109	373	373	373	373	362	352	341
3	159	135	130	127	125	106	80	273	273	273	273	265	257	249
4	150	127	122	120	117	100	75	257	257	257	257	250	242	235
5	151	129	124	121	119	101	76	260	260	260	260	252	245	237
6	148	126	121	119	116	99	74	255	255	255	255	247	240	232
8	146	124	119	117	114	97	73	251	251	251	251	244	236	229

* Based on maximum allowable stress in tension (psi) for the indicated temperatures (°F), see **Pressure Ratings and Burst Strength**.
 ** When brazing or welding is used to join drawn tube, the corresponding annealed rating must be used, see **Pressure Ratings and Burst Strength**.
 *** Types M and DWV are not normally available in the annealed temper. Shaded values are provided for guidance when drawn temper tube is brazed or welded, see **Pressure Ratings and Burst Strength**.

* Based on maximum allowable stress in tension (psi) for the indicated temperatures (F).
 ** When brazing or welding is used to join drawn tube, the corresponding annealed rating must be used.
 *** Types M and DWV are not normally available in the annealed temper. Shaded values are provided for guidance when drawn temper tube is brazed or welded. For more information, see **Pressure Ratings and Burst Strength**.

TABLE 14.3e. Calculated Rated Internal Working Pressure for Copper Tube: ACR*** (Air Conditioning and Refrigeration Field Service)

Nominal or standard size, in inches	Annealed							Drawn**						
	Coils							Straight Lengths						
	S= 6000 psi 100F	S= 5100 psi 150F	S= 4900 psi 200F	S= 4800 psi 250F	S= 4700 psi 300F	S= 4000 psi 350F	S= 3000 psi 400F	S= 10,300 psi 100F	S= 10,300 psi 150F	S= 10,300 psi 200F	S= 10,300 psi 250F	S= 10,000 psi 300F	S= 9,700 psi 350F	S= 9,400 psi 400F
1/8	3074	2613	2510	2459	2408	2049	1537	*	*	*	*	*	*	*
3/16	1935	1645	1581	1548	1516	1290	968	*	*	*	*	*	*	*
1/4	1406	1195	1148	1125	1102	938	703	*	*	*	*	*	*	*
5/16	1197	1017	977	957	937	798	598	*	*	*	*	*	*	*
3/8	984	836	803	787	770	656	492	*	*	*	*	*	*	*
1/2	727	618	594	581	569	485	363	*	*	*	*	*	*	*
5/8	618	525	504	494	484	412	309	*	*	*	*	*	*	*
3/4	511	435	417	409	400	341	256	*	*	*	*	*	*	*
7/8	631	537	516	505	495	421	316	*	*	*	*	*	*	*
1	582	495	475	466	456	388	291	*	*	*	*	*	*	*
1 1/8	494	420	404	395	387	330	247	*	*	*	*	*	*	*
1 1/4	439	373	358	351	344	293	219	*	*	*	*	*	*	*
1 1/2	408	347	334	327	320	272	204	*	*	*	*	*	*	*
Straight Lengths														
1/4	1159	985	946	927	908	773	579	1989	1989	1989	1989	1931	1873	1815
3/8	914	777	747	731	716	609	457	1569	1569	1569	1569	1524	1478	1432
1/2	781	664	638	625	612	521	391	1341	1341	1341	1341	1302	1263	1224
5/8	723	615	591	579	567	482	362	1242	1242	1242	1242	1206	1169	1133
3/4	633	538	517	506	496	422	316	1086	1086	1086	1086	1055	1023	991
7/8	583	496	477	467	457	389	292	1002	1002	1002	1002	972	943	914
1	495	421	404	396	388	330	248	850	850	850	850	825	801	776
1 1/8	440	374	359	352	344	293	220	755	755	755	755	733	711	689
1 1/4	409	348	334	327	320	273	205	702	702	702	702	682	661	641
1 1/2	364	309	297	291	285	243	182	625	625	625	625	607	589	570
2	336	286	275	269	263	224	168	577	577	577	577	560	544	527
3	317	270	259	254	249	212	159	545	545	545	545	529	513	497
3 1/2	304	258	248	243	238	203	152	522	522	522	522	506	491	476
4	293	249	240	235	230	196	147	504	504	504	504	489	474	460

* Not commercially available.
 ** When brazing or welding is used to join drawn tube, the corresponding annealed rating must be used, see **Pressure Ratings and Burst Strength**.
 *** Based on maximum allowable stress in tension (psi) for the indicated temperatures (°F), see **Pressure Ratings and Burst Strength**.

TABLE 14.4a. Pressure-Temperature Ratings of Soldered and Brazed Joints

Joining material ⁴	Service temperature °F	Fitting type	Maximum working gage pressure (psi), for standard water tube sizes ¹				
			Nominal or standard size, inches				
			1/8 - 1	1 1/4 - 2	2 1/4 - 4	5 - 8	10 - 12
Alloy Sn50 50-50 Tin-Lead Solder ⁵	100	Pressure ²	200	175	150	135	100
		DWV ³	-	95	80	70	-
	150	Pressure ²	150	125	100	90	70
		DWV ³	-	70	55	45	-
	200	Pressure ²	100	90	75	70	50
		DWV ³	-	50	40	35	-
250	Pressure ²	85	75	50	45	40	
	DWV ³	-	-	-	-	-	
Saturated steam	Pressure	15	15	15	15	15	
Alloy Sb5 95-5 Tin-Antimony Solder	100	Pressure ²	1090	850	705	660	500
		DWV ³	-	390	325	330	-
	150	Pressure ²	625	485	405	375	285
		DWV ³	-	225	185	190	-
	200	Pressure ²	505	395	325	305	230
		DWV ³	-	180	150	155	-
250	Pressure ²	270	210	175	165	125	
	DWV ³	-	95	80	80	-	
Saturated steam	Pressure	15	15	15	15	15	
Alloy E	100	Pressure ²	710	555	460	430	325
		DWV ³	-	255	210	215	-
	150	Pressure ²	475	370	305	285	215
		DWV ³	-	170	140	140	-
	200	Pressure ²	375	290	240	225	170
		DWV ³	-	135	110	115	-
250	Pressure ²	320	250	205	195	145	
	DWV ³	-	115	95	95	-	
Saturated steam	Pressure	15	15	15	15	15	
Alloy HB	100	Pressure ²	1035	805	670	625	475
		DWV ³	-	370	310	315	-
	150	Pressure ²	710	555	460	430	325
		DWV ³	-	255	210	215	-
	200	Pressure ²	440	345	285	265	200
		DWV ³	-	155	130	135	-
250	Pressure ²	430	335	275	260	195	
	DWV ³	-	155	125	130	-	
Saturated steam	Pressure	15	15	15	15	15	
Joining materials melting at or above 1100°F ⁶	Pressure-temperature ratings consistent with the materials and procedures employed (see Table 14.3, annealed)						
Saturated steam	Pressure	120	120	120	120	120	

For extremely low working temperatures in the 0°F to minus 200°F range, it is recommended that a joint material melting at or above 1100°F be employed (see reference⁶).

- Standard water tube sizes per ASTM B88.
- Ratings up to 8 inches in size are those given in ASME B16.22 *Wrought Copper and Copper Alloy Solder Joint Pressure Fittings* and ASME B16.18 *Cast Copper and Copper Alloy Solder Joint Fittings*. Rating for 10- to 12-inch sizes are those given in ASME B16.18 *Cast Copper and Copper Alloy Solder Joint Pressure Fittings*.
- Using ASME B16.29 *Wrought Copper and Wrought Copper Alloy Solder Joint Drainage Fittings — DWV*, and ASME B16.23 *Cast Copper Alloy Solder Joint Drainage Fittings — DWV*.
- Alloy designations are per ASTM B32.
- The Safe Drinking Water Act Amendment of 1986 prohibits the use in potable water systems of any solder having a lead content in excess of 0.2%.
- These joining materials are defined as brazing alloys by the American Welding Society.

TABLE 14.4b. Pressure-Temperature Ratings of No-flame Joints

Joint type		Pressure range ¹	Temperature range ¹
Press-connect (General Piping Applications) ½"-4"		0-200 psig (1375 kPa)	0°F - 250°F (-18°C - 121°C)
Press-connect for High-Pressure HVACR ¼"-1½"		0-700 psig (4826 kPa)	-25°F - 300°F (-32°C - 149°C)
Push-connect ² ½"-2"		0-200 psig (1375 kPa)	0°F - 250°F (-18°C - 121°C)
Roll-groove ² 2"-8" Types K & L		0-300 psig (2065 kPa)	-30°F - 250°F (-34°C - 121°C) -20°F - 180°F (-29°C - 82°C)
Roll-groove ³	2"-4" Type M	0-250 psig (1725 kPa)	-30°F - 250°F (-34°C - 121°C)
	5"-8" Type M	0-200 psig (1375 kPa)	-20°F - 180°F (-29°C - 82°C)

TABLE 14.5. Actual Burst Pressures,¹ Types K, L and M Copper Water Tube, psi at Room Temperature

Nominal or standard size, inches	Actual outside diameter, in.	K		L ²		M	
		Drawn	Annealed	Drawn	Annealed	Drawn	Annealed
½	⅝	9840	4535	7765	3885	6135	-
¾	⅞	9300	4200	5900	2935	4715	-
1	1⅛	7200	3415	5115	2650	3865	-
1¼	1⅜	5525	2800	4550	2400	3875	-
1½	1⅝	5000	2600	4100	2200	3550	-
2	2⅛	3915	2235	3365	1910	2935	-
2½	2⅝	3575	-	3215	-	2800	-
3	3⅛	3450	-	2865	-	2665	-
4	4⅛	3415	-	2865	-	2215	-
5	5⅛	3585	-	2985	-	2490	-
6	6⅛	3425	-	2690	-	2000	-
8	8⅛	3635	-	2650	-	2285	-

1. Actual pressure/temperature ranges should be confirmed based upon the specific manufacturer's fittings being utilized.
 2. Some manufacturers' systems are rated to below 0°F (-18°C) and may not be rated or recommended to 250°F (121°C).
 3. Temperature ranges for various gasket types and clamping systems must be confirmed with the specific gasket and clamp manufacturer.

1. The figures shown are averages of three certified tests performed on each type and size of water tube. In each case wall thickness was at or near the minimum prescribed for each tube type. No burst pressure in any test deviated from the average by more than 5 percent.
 2. These burst pressures can be used for ACR tube of equivalent actual O.D. and wall thickness.

TABLE 14.7. Pressure Loss in Fittings and Valves Expressed as Equivalent Length of Tube, feet

Nominal or standard size, inches	Fittings				Valves				
	Standard ell		90° tee		Coupling	Ball	Gate	Btfly	Check
	90°	45°	Side branch	Straight run					
3/8	.5	-	1.5	-	-	-	-	-	1.5
1/2	1	.5	2	-	-	-	-	-	2
5/8	1.5	.5	2	-	-	-	-	-	2.5
3/4	2	.5	3	-	-	-	-	-	3
1	2.5	1	4.5	-	-	.5	-	-	4.5
1 1/4	3	1	5.5	.5	.5	.5	-	-	5.5
1 1/2	4	1.5	7	.5	.5	.5	-	-	6.5
2	5.5	2	9	.5	.5	.5	.5	7.5	9
2 1/2	7	2.5	12	.5	.5	-	1	10	11.5
3	9	3.5	15	1	1	-	1.5	15.5	14.5
3 1/2	9	3.5	14	1	1	-	2	-	12.5
4	12.5	5	21	1	1	-	2	16	18.5
5	16	6	27	1.5	1.5	-	3	11.5	23.5
6	19	7	34	2	2	-	3.5	13.5	26.5
8	29	11	50	3	3	-	5	12.5	39

NOTES: Allowances are for streamlined soldered fittings and recessed threaded fittings. For threaded fittings, double the allowances shown in the table. The equivalent lengths presented above are based upon a C factor of 150 in the Hazen-Williams friction loss formula. The lengths shown are rounded to the nearest half foot.

TABLE 14.7a. Pressure Loss in HVACR Elbows Expressed as Equivalent Length of Tube, feet

Outside Diameter, inches	90° Elbows	
	Short Radius*	Long Radius
1/4	.7	.6
5/16	.8	.7
3/8	.9	.8
1/2	1.2	1.0
5/8	1.5	1.3
3/4	1.6	1.4
1	2.5	1
7/8	1.8	1.6
1 1/8	2.4	2.0
1 1/4	3.2	2.2
1 5/8	3.8	2.6
2 1/8	5.2	3.4
2 5/8	6.5	4.2

NOTE: * Two 45° radius ells equal one 90° short-radius ell.

TABLE 14.8. Radii of Coiled Expansion Loops and Developed Lengths of Expansion Offsets

Expected expansion, inches		Radius R, inches, for nominal or standard tube sizes shown										Radius L, inches, for nominal or standard tube sizes shown			
		1/4	3/8	1/2	3/4	1	1 1/4	1 1/2	2	2 1/2	3	3 1/2	4	5	
1/2	R	6	7	8	9	11	12	13	15	16	18	19	20	23	
	L	38	44	50	59	67	74	80	91	102	111	120	128	142	
1	R	9	10	11	13	15	17	18	21	23	25	27	29	32	
	L	54	63	70	83	94	104	113	129	144	157	169	180	201	
1 1/2	R	11	12	14	16	18	20	22	25	28	30	33	35	39	
	L	66	77	86	101	115	127	138	158	176	191	206	220	245	
2	R	12	14	16	19	21	23	25	29	32	35	38	41	45	
	L	77	89	99	117	133	147	160	183	203	222	239	255	284	
2 1/2	R	14	16	18	21	24	26	29	33	36	40	43	45	51	
	L	86	99	111	131	149	165	179	205	227	248	267	285	318	
3	R	15	17	19	23	26	29	31	36	40	43	47	50	55	
	L	94	109	122	143	163	180	196	224	249	272	293	312	348	
3 1/2	R	16	19	21	25	28	31	34	39	43	47	50	54	60	
	L	102	117	131	155	176	195	212	242	269	293	316	337	376	
4	R	17	20	22	26	30	33	36	41	46	50	54	57	64	
	L	109	126	140	166	188	208	226	259	288	314	338	361	402	

TABLE 14.9. Dimensions of Solder Joint Ends for Wrought (W) and Cast (C) Pressure Fittings, inches

Nominal or standard fittings size, inches	Type	Male end		Female end			For use with tube size				
		Outside diameter A		Length K	Inside diameter F		Depth G	under ASTM B 88	under ASTM B 280	under ASTM B 819	under ASTM B 837
		Min.	Max.	Min.	Min.	Max.	Min.				
1/8	W	.248	.251	.38	.252	.256	.31	*	1/4	*	1/4
1/4	C W	.373	.376	.38	.377	.381	.31	1/4	3/8	1/4	3/8
3/8	C W	.497	.501	.44	.502	.506	.38	3/8	1/2	3/8	1/2
1/2	C W	.622	.626	.56	.627	.631	.50	1/2	5/8	1/2	5/8
5/8	W	.747	.751	.81	.752	.756	.75	5/8	3/4	5/8	3/4
3/4	C W	.872	.876	.81	.877	.881	.75	3/4	7/8	3/4	7/8
1	C W	1.122	1.127	.97	1.128	1.132	.91	1	1 1/8	1	1 1/8
1 1/4	C W	1.372	1.377	1.03	1.378	1.382	.97	1 1/4	1 3/8	1 1/4	*
1 1/2	C W	1.621	1.627	1.16	1.628	1.633	1.09	1 1/2	1 3/4	1 1/2	*
2	C W	2.121	2.127	1.41	2.128	2.133	1.34	2	2 1/8	2	*
2 1/2	C W	2.621	2.627	1.53	2.628	2.633	1.47	2 1/2	2 3/8	2 1/2	*
3	C W	3.121	3.127	1.72	3.128	3.133	1.66	3	3 1/8	3	*
3 1/2	C W	3.621	3.627	1.97	3.628	3.633	1.91	3 1/2	3 3/8	3 1/2	*
4	C W	4.121	4.127	2.22	4.128	4.133	2.16	4	4 1/8	4	*
5	C W	5.121	5.127	2.72	5.128	5.133	2.66	5	*	5	*
6	C W	6.121	6.127	3.22	6.128	6.133	3.09	6	*	6	*
8	C W	8.119	8.127	4.09	8.128	8.133	3.97	8	*	8	*
10	C	10.119	10.127	4.12	10.128	10.133	4.00	10	*	*	*
12	C	12.119	12.127	4.62	12.128	12.133	4.50	12	*	*	*

C = Cast, W = Wrought, * = Not commercially available

TABLE 14.10. Solder Requirements for Solder Joint Pressure Fittings, length in inches*

Nominal or standard size, inches	O.D. of tube, inches	Cup depth of fitting, inches	Joint clearance, inches										Wt. in lbs. at .010 clearance per 100 joints***
			0.001	0.002	0.003	0.004	0.005**	0.006	0.007	0.008	0.009	0.010***	
¼	.375	.310	.030	.060	.089	.119	.149	.179	.208	.238	.268	.298	.097
⅜	.500	.380	.049	.097	.146	.195	.243	.292	.341	.389	.438	.486	.159
½	.625	.500	.080	.160	.240	.320	.400	.480	.560	.640	.720	.800	.261
⅝	.750	.620	.119	.238	.357	.476	.595	.714	.833	.952	1.072	1.191	.389
¾	.875	.750	.168	.336	.504	.672	.840	1.008	1.176	1.344	1.512	1.680	.548
1	1.125	.910	.262	.524	.786	1.048	1.311	1.573	1.835	2.097	2.359	2.621	.856
1¼	1.375	.970	.341	.683	1.024	1.366	1.707	2.049	2.390	2.732	3.073	3.415	1.115
1½	1.625	1.090	.454	.907	1.361	1.814	2.268	2.721	3.175	3.628	4.082	4.535	1.480
2	2.125	1.340	.729	1.458	2.187	2.916	3.645	4.374	5.103	5.833	6.562	7.291	2.380
2½	2.625	1.470	.988	1.976	2.964	3.952	4.940	5.928	6.916	7.904	8.892	9.880	3.225
3	3.125	1.660	1.328	2.656	3.985	5.313	6.641	7.969	9.297	10.626	11.954	13.282	4.335
3½	3.625	1.910	1.773	3.546	5.318	7.091	8.864	10.637	12.409	14.182	15.955	17.728	5.786
4	4.125	2.160	2.281	4.563	6.844	9.125	11.407	13.688	15.969	18.250	20.532	22.813	7.446
5	5.125	2.660	3.490	6.981	10.471	13.962	17.452	20.943	24.433	27.924	31.414	34.905	11.392
6	6.125	3.090	4.846	9.692	14.538	19.383	24.229	29.075	33.921	38.767	43.613	48.459	15.815
8	8.125	3.970	8.259	16.518	24.777	33.035	41.294	49.553	57.812	66.071	74.330	82.589	26.955
10	10.125	4.000	10.370	20.739	31.109	41.478	51.848	62.218	72.587	82.957	93.326	103.696	33.845
12	12.125	4.500	13.970	27.940	41.910	55.881	69.851	83.821	97.791	111.761	125.731	139.701	45.596

* Using ⅜-inch diameter (No. 9) Wire Solder (1 inch length=.01227 cubic inches).

** Actual consumption depends on workmanship.

*** Includes an allowance of 100% to cover wastage and loss.

Note: Flux requirements are usually 2 oz. per lb of solder.

TABLE 14.11. Typical Brazing Filler Metal Consumption

Tube, nominal or standard size, inches	Filler Metal Length, inches				Average weight per 100 joints, pounds*
	⅜ inch wire	⅜ in x .050 in rod	⅜ inch wire	⅜ inch wire	
¼	½	¼	¼	⅛	.04
⅜	⅝	⅜	⅜	¼	.06
½	1⅞	58	12	⅜	.10
⅝	1⅞	78	58	½	.15
¾	2¼	118	1	58	.21
1	3½	134	158	78	.32
1¼	4½	214	2	114	.42
1½	-	3	258	112	.56
2	-	434	438	212	.90
2½	-	612	578	338	1.22
3	-	858	778	412	1.64
3½	-	1112	1012	578	2.18
4	-	1478	1312	758	2.81
5	-	2258	2012	1158	4.30
6	-	3112	2812	16	5.97
8	-	5312	4812	2738	10.20
10	-	6714	61	3414	12.77
12	-	9012	82	4618	17.20

* The amount of filler metal indicated is based on an average two-thirds penetration of the cup and with no provision for a filler. For estimating purposes, actual consumption may be two to three times the amounts indicated in this table, depending on the size of joints, method of application and level of workmanship.

NOTE: 1090 inches of ⅜-inch wire = 1 pound
 534 inches of ⅜-inch x .050-inch rod = 1 pound
 484 inches of ⅜-inch wire = 1 pound
 268 inches of ⅜-inch wire = 1 pound

TABLE 14.12. Filler Metals for Brazing

AWS Classification ¹	Principal Elements, percent							Temperature °F	
	Silver (Ag)	Phosphorous (P)	Zinc (Zn)	Cadmium (Cd)	Tin (Sn)	Copper (Cu)	Silicon (Si)	Solidus	Liquidus
BCuP-2	-	7.0-7.5	-	-	-	Remainder	-	1310	1460
BCuP-3	4.8-5.2	5.8-6.2	-	-	-	Remainder	-	1190	1495
BCuP-4	5.8-6.2	7.0-7.5	-	-	-	Remainder	-	1190	1325
BCuP-5	14.5-15.5	4.8-5.2	-	-	-	Remainder	-	1190	1475
BCuP-6	1.8-2.2	6.8-7.2	-	-	-	Remainder	-	1190	1450
BCuP-7	4.8- 5.2	6.5-7.0	-	-	-	Remainder	-	1190	1420
BCuP-8	17.2-18.0	6.0- 6.7	-	-	-	Remainder	-	1190	1230
BCuP-9	-	6.0- 7.0	-	-	6.0-7.0	Remainder	0.01-0.4	1178	1247
BAG-5	44.0-46.0	-	23.0-27.0	-	-	29.0-31.0	-	1225	1370
BAG-6	49.0-51.0	-	14.0-18.0	-	-	33.0-35.0	-	1270	1425
BAG-7 ²	55.0-57.0	-	15.0-19.0	-	4.5-5.5	21.0-23.0	-	1145	1205
BAG-20	29.0-31.0	-	30.0-34.0	-	-	37.0-39.0	-	1250	1410
BAG-28	39.0-41.0	-	26.0-30.0	-	1.5-2.5	29.0-31.0	-	1200	1310
BAG-34 ³	37.0-34.0	-	26.0-30.0	-	1.5-2.5	31.0-33.0	-	1200	1330

¹ ANSI/AWS A5.8 Specification for Filler Metals for Breazing.
² BAG-7 is a common, cadmium-free substitute for BAG-1.
³ BAG-34 is a common, cadmium-free substitute for BAG-2 and BAG-2a.

FIGURE 14.1. Collapse Pressure of Copper Tube, Types K, L and M

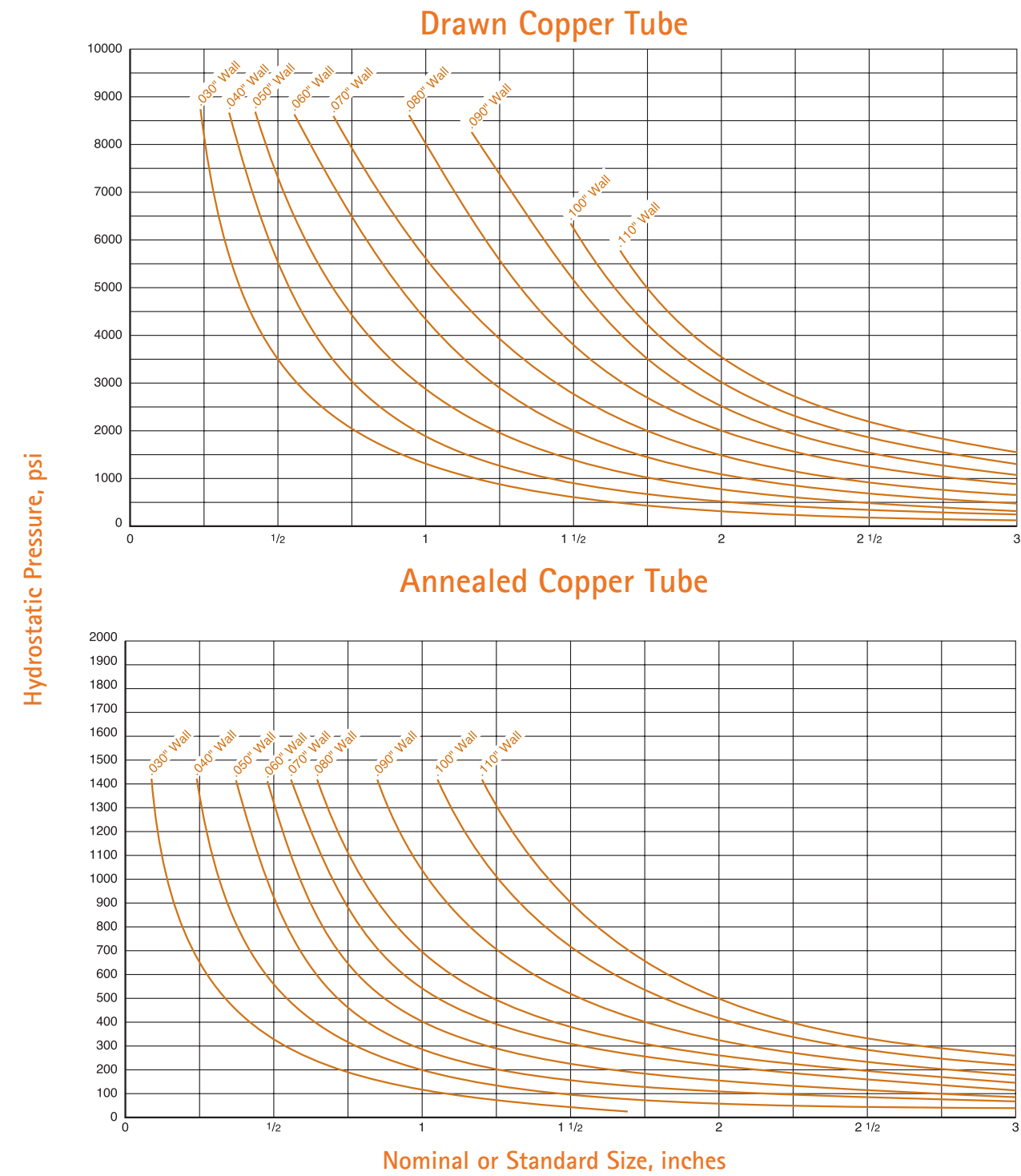

FIGURE 14.2. Expansion vs. Temperature Change for Copper Tube

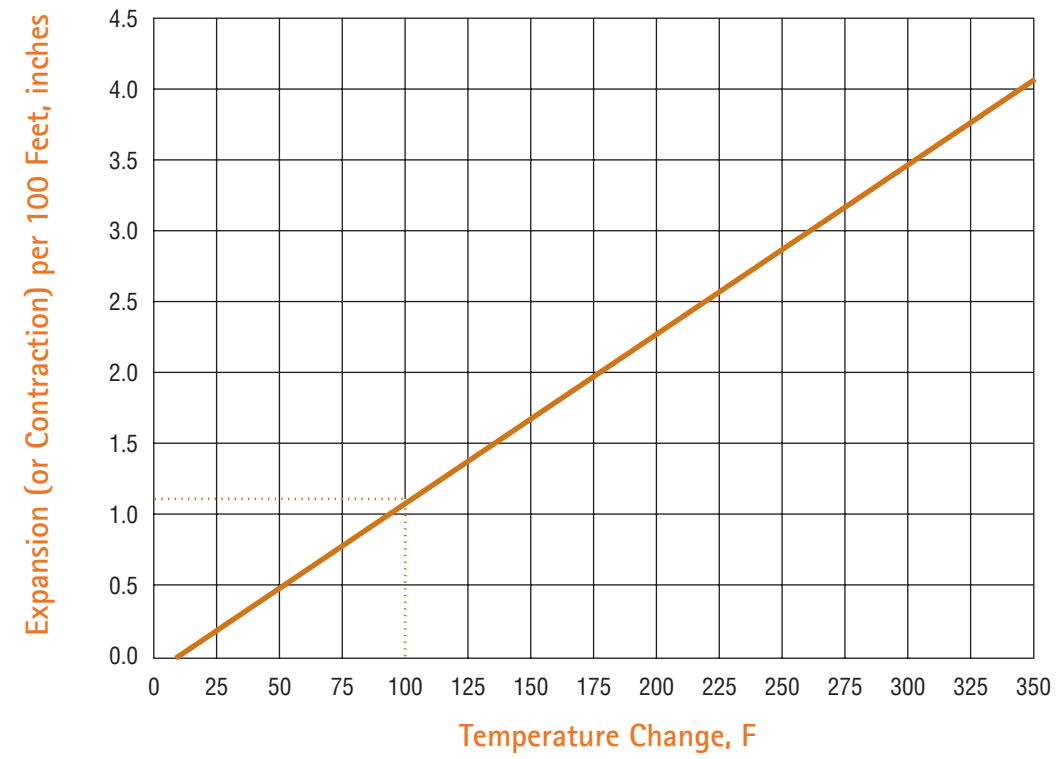

FIGURE 14.3 Coiled Expansion Loops and Expansion Offsets

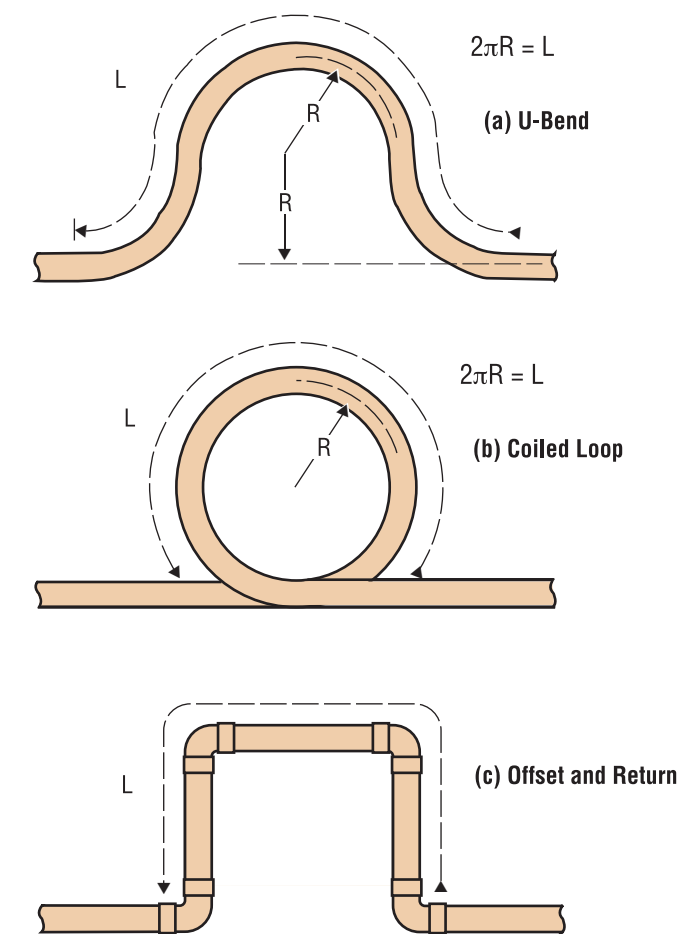
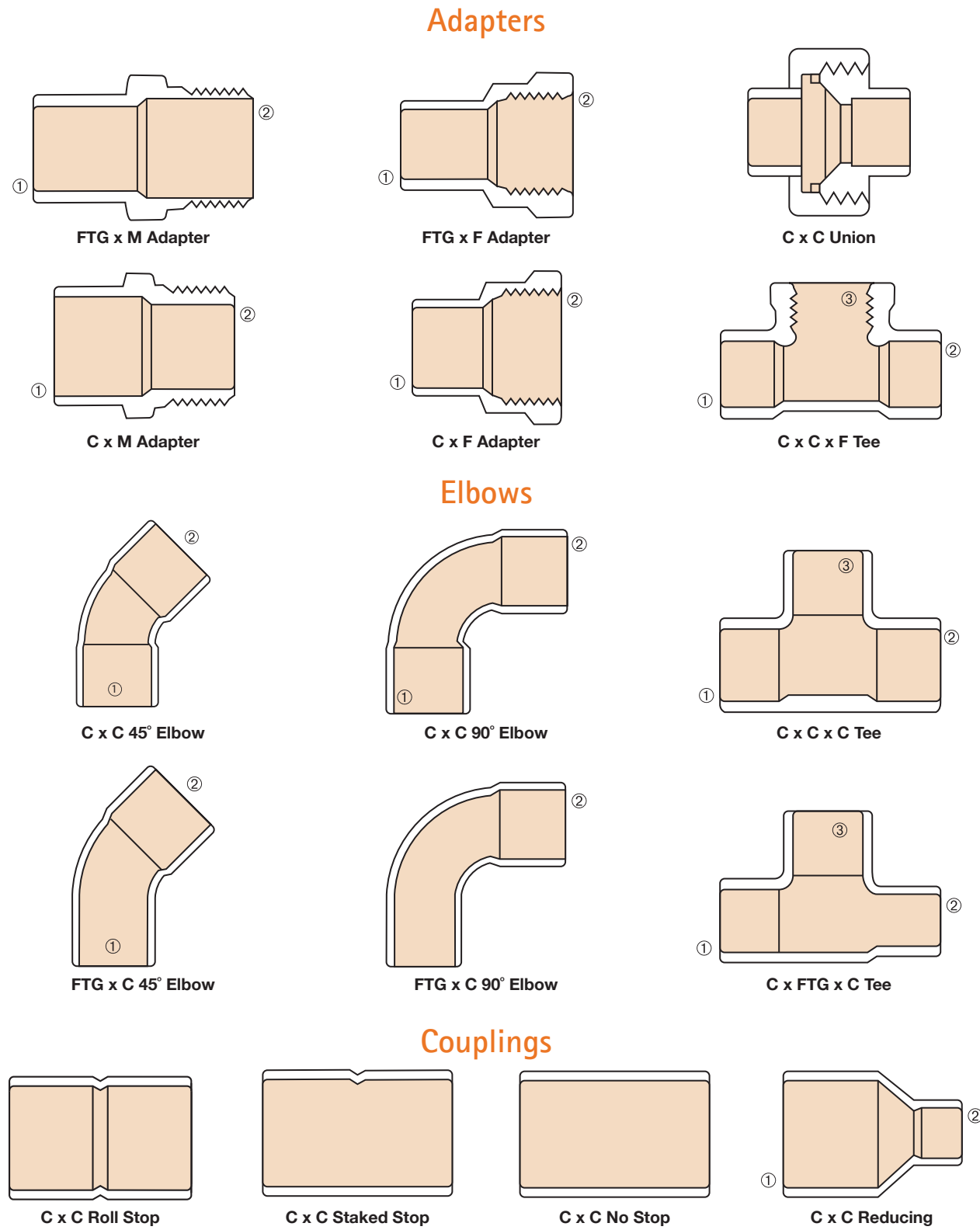
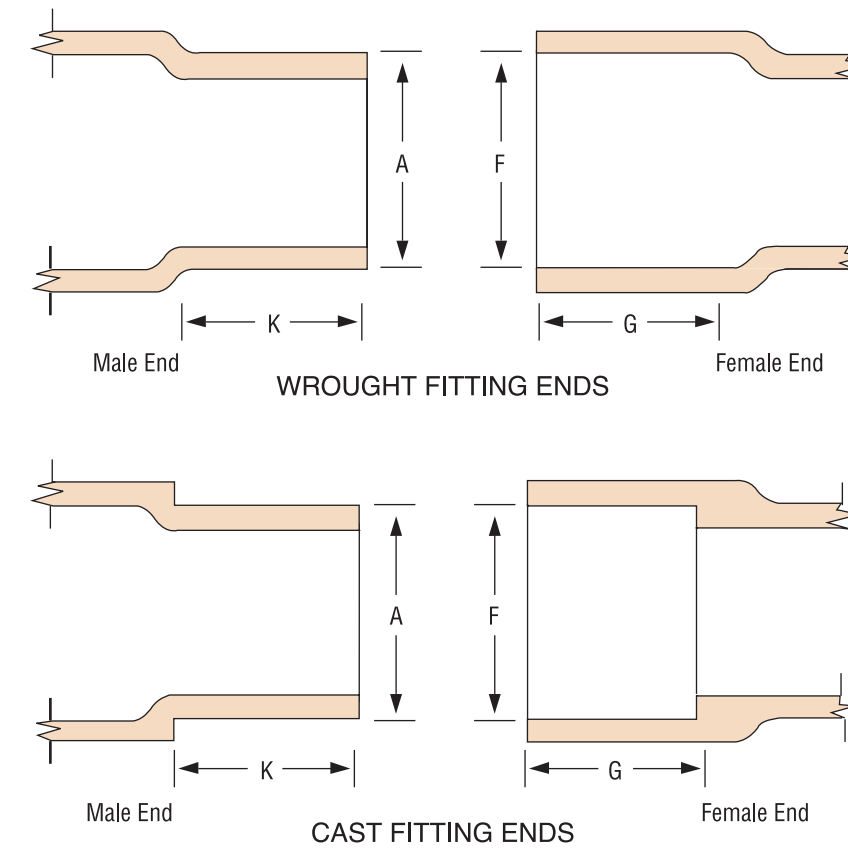

FIGURE 14.4. Selected Pressure Fittings



NOTES: Fittings are designated by size in the order: 1x2x3. Fitting designs and drawings are for illustration only.

FIGURE 14.5. Dimensions of Solder Joint Fitting Ends



NOTES: Drawings and designs of fittings are for illustration only.

FIGURE 14.6. Melting Temperature Ranges for Copper and Copper Alloys, Brazing Filler Metals, Brazing Flux and Solders

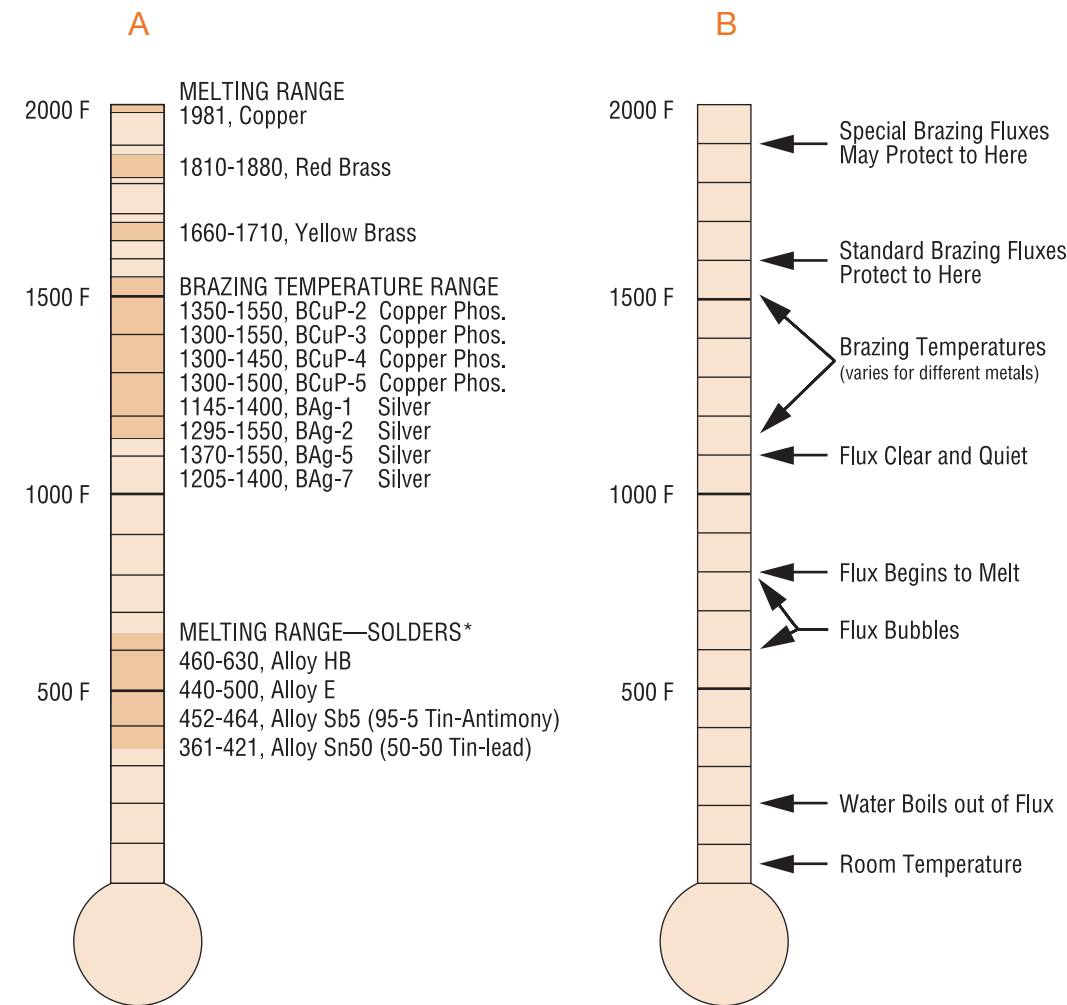

* Melting ranges of solder alloys are in accordance with the alloy manufacturers' product information and may not match the melting ranges shown in ASTM B32.

FIGURE 14.7. Brazing Flux Recommendations

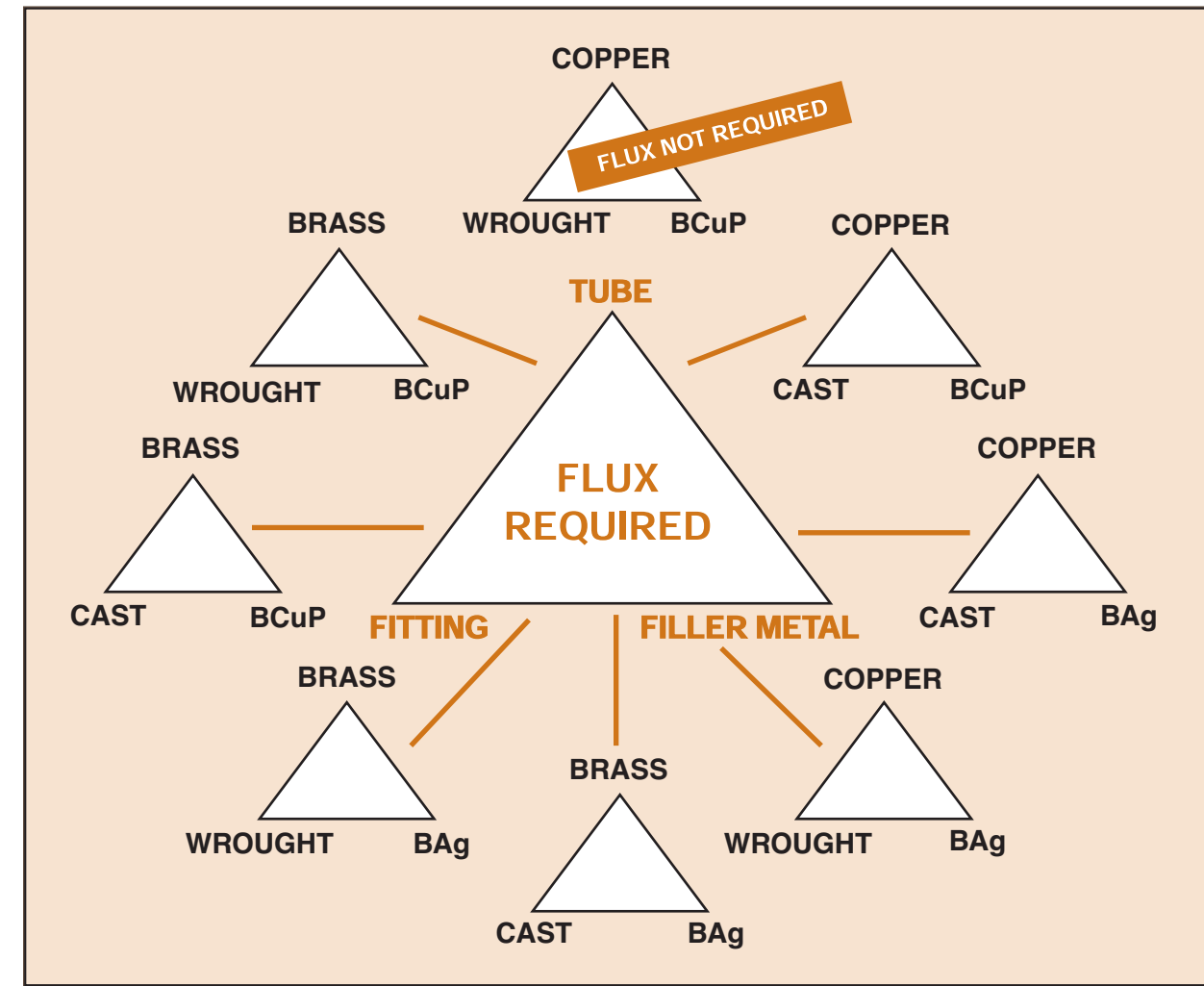

Triangles, denoting when to use flux, are surrounded by tube type, fitting type and brazing filler type.

NOTE:
When joining copper tube to a wrought fitting using BCuP filler, no flux is required.



**Copper Development
Association Inc.**
Copper Alliance

1660 International Dr. Suite 600
McLean, VA 22102
www.copper.org

A4015-14/20